

Data Sheet

R-Series V RF5 SSI

Magnetostrictive Linear Position Sensors

Improved
flexible
sensor rod

- Flexible sensor rod with improved features
- Stroke length up to 20 m
- Field adjustments and diagnostics using the TempoLink® and TempoGate® smart assistants



V
THE NEW GENERATION

MEASURING TECHNOLOGY

The absolute, linear position sensors provided by Temposonics rely on the company's proprietary magnetostrictive technology, which can determine position with a high level of precision and robustness. Each Temposonics® position sensor consists of a ferromagnetic waveguide, a position magnet, a strain pulse converter and supporting electronics. The magnet, connected to the object in motion in the application, generates a magnetic field at its location on the waveguide. A short current pulse is applied to the waveguide. This creates a momentary radial magnetic field and torsional strain on the waveguide. The momentary interaction of the magnetic fields releases a torsional strain pulse that propagates the length of the waveguide. When the ultrasonic wave reaches the beginning of the waveguide it is converted into an electrical signal. Since the speed of the ultrasonic wave in the waveguide is precisely known, the time required to receive the return signal can be converted into a linear position measurement with both high accuracy and repeatability.

R-SERIES V RF5 SSI

The Temposonics® R-Series V brings very powerful sensor performance to meet the many demands of your application. The RF5 sensor is the R-Series V with improved flexible sensor rod. The main advantages of the flexible sensor rod are:

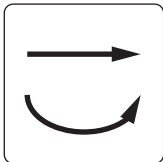

Straight and curved line
The flexible sensor rod enables position measurement on straight and also curved line.

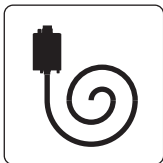

Compact for transport and storage
For transport and storage, the RF5 sensor can be coiled up. This saves costs and space.

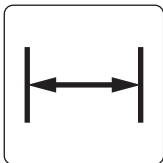

Installation with little space
Due to the bendable rod, the RF5 sensor can be installed even if only little space is available.

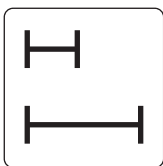

Large stroke length range
The sensor is available with stroke lengths from 150 mm to 20,000 mm and thus can be used in both short and long distance applications.

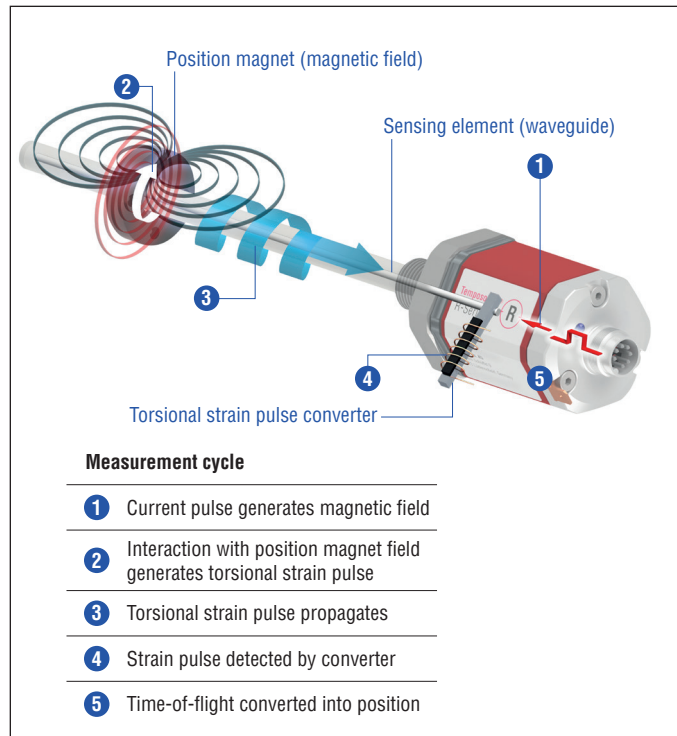
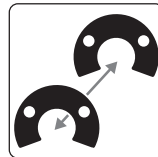

Fig. 1: Time-of-flight based magnetostrictive position sensing principle

In addition the R-Series V SSI scores with the following features:



Differential measurement between 2 positions
The R-Series V SSI can measure and output the distance between 2 position magnets.



R-Series V SSI
The interface of the R-Series V SSI corresponds to the SSI industry standard for absolute encoders. You can select the configuration of the SSI signal that fits best to your application and also adjust it on site with the smart assistants.

All settings under control with the smart assistants for the R-Series V

The TempoLink® and the TempoGate® smart assistants support you in setup and diagnostics of the R-Series V. For more information of these assistants please see the data sheets:

- TempoLink® smart assistant (Document part number: [552070](#))
- TempoGate® smart assistant (Document part number: [552110](#))



ADVANTAGES OF THE R-SERIES V RF5 COMPARED TO THE R-SERIES V RFV

R-Series V RFV
(previous design)



R-Series V RF5
(improved design)



The first magnetostrictive sensor with a flexible sensor rod was developed and introduced to the market by Temposonics over 25 years ago. With this experience, we have further developed the sensor to improve handling in your application. The R-Series V RF5 offers you the following advantages:

Shortened non-flexible area

- Compared to the previous design, the non-flexible area of the RF5 has been reduced by more than 70 % from 107 mm to 30 mm.
- *This makes it easier to install the sensor, especially in confined spaces.*

Smooth transition

- The transition between the non-flexible and flexible areas is designed to be smooth.
- *This makes it easier to install the sensor in your application.*

Reduced outer diameter and bending radius

- The outer diameter of the flexible sensor rod has been reduced to 6.4 mm
- This now allows a minimum bending radius of the flexible sensor rod of 100 mm.
- *This makes it easier to install the sensor, especially in confined spaces.*

Increased ingress protection

- The RF5-B base unit meets the ingress protection IP68 (3 d/3 m) (connectors and flange correctly fitted).
- Therefore, the internal waveguide is protected against the ingress of water.
- *This improves the longevity of the sensor in your application.*

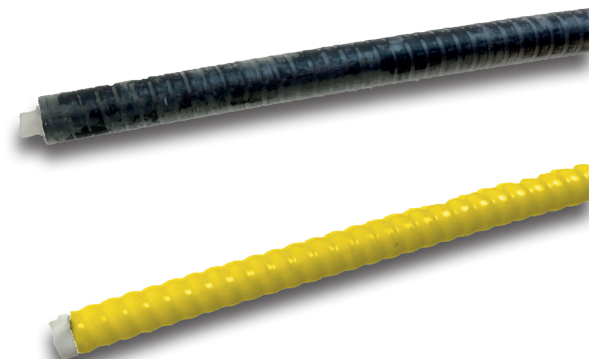

TECHNICAL DATA

Output								
Interface	SSI (Synchronous Serial Interface) – differential signal in SSI standard (RS-485/RS-422)							
Data format	Binary or gray							
Data length	8...32 bit							
Data transmission rate	70 kBaud ¹ ...1 MBaud, depending on cable length:							
	Cable length	< 3 m	< 50 m	< 100 m	< 200 m	< 400 m		
	Baud rate	1 MBd	< 400 kBd	< 300 kBd	< 200 kBd	< 100 kBd		
Measured value	Position or velocity, position and temperature in sensor electronics housing							
Measurement parameters								
Resolution: Position	0.1...100 µm (0.0001...0.1 mm)							
Resolution: Velocity	0.001 mm/s (determined over 10 measured values)							
Update rate ²	Stroke length	300 mm	750 mm	1000 mm	2000 mm	7620 mm	10,000 mm	20,000 mm
	Update rate	3.4 kHz	2.7 kHz	2.1 kHz	1.2 kHz	0.3 kHz	0.25 kHz	0.125 kHz
Linearity deviation ³	< ±0.02 % F.S. (minimum ±100 µm)							
Repeatability	< ±0.001 % F.S. (minimum ±2.5 µm) typical							
Hysteresis	< 4 µm typical							
Temperature coefficient	< 15 ppm/K typical							
Operating conditions								
Operating temperature	-40...+85 °C (-40...+185 °F)							
Humidity	90 % relative humidity, no condensation							
Ingress protection	IP68 (connectors and flange correctly fitted)							
Shock test	100 g/6 ms, IEC standard 60068-2-27 (when guided in a support tube, e.g. sensor rod HD/HL/HP)							
Vibration test	5 g/10...2000 Hz, IEC standard 60068-2-6 (excluding resonant frequencies) (when guided in a support tube, e.g. sensor rod HD/HL/HP)							
EMC test	Electromagnetic emission according to EN 61000-6-3							
	Electromagnetic immunity according to EN 61000-6-2							
	With EMC-compliant installation, the RF5 sensors fulfill the requirements of EMC directives 2014/30/EU, UKSI 2016 No. 1091 and TR ZU 020/2011. ⁴							
Magnet movement velocity	Any							
Design/Material								
Sensor electronics housing	Aluminum (painted), zinc die cast							
Sensor flange	Stainless steel 1.4305 (AISI 303)							
Sensor rod	Stainless steel conduit with PU coating							
RoHS compliance	The used materials are compliant with the requirements of EU Directive 2011/65/EU and EU Regulation 2015/863 as well as UKSI 2022 No. 622 with amendments							
Stroke length	150...20,000 mm (6...787 in.)							
Mechanical mounting								
Mounting position	Any							
Mounting instruction	Please consult the technical drawings on page 6 and page 7 and the operation manual (document part number: 552011)							

Technical data “Electrical connection” on [page 5](#)

1/ With standard one shot of 16 µs

2/ Sensor with standard settings. Further information can be found in the operation manual R-Series V SSI (document part number: [552011](#))

3/ With position magnet # 251 416-2

4/ The flexible sensor element must be mounted in an appropriately shielded environment

Electrical connection	
Connection type	1 × M16 male connector (7 pin) or 1 × M12 male connector (8 pin) or cable outlet
Operating voltage	+12...30 VDC ±20 % (9.6...36 VDC); the RF5 sensors must be power supplied via an external Class 2 power source in accordance with the UL approval
Power consumption	1.2 W typical
Dielectric strength	500 VDC (DC ground to machine ground)
Polarity protection	Up to -36 VDC
Overvoltage protection	Up to 36 VDC

TECHNICAL DRAWING

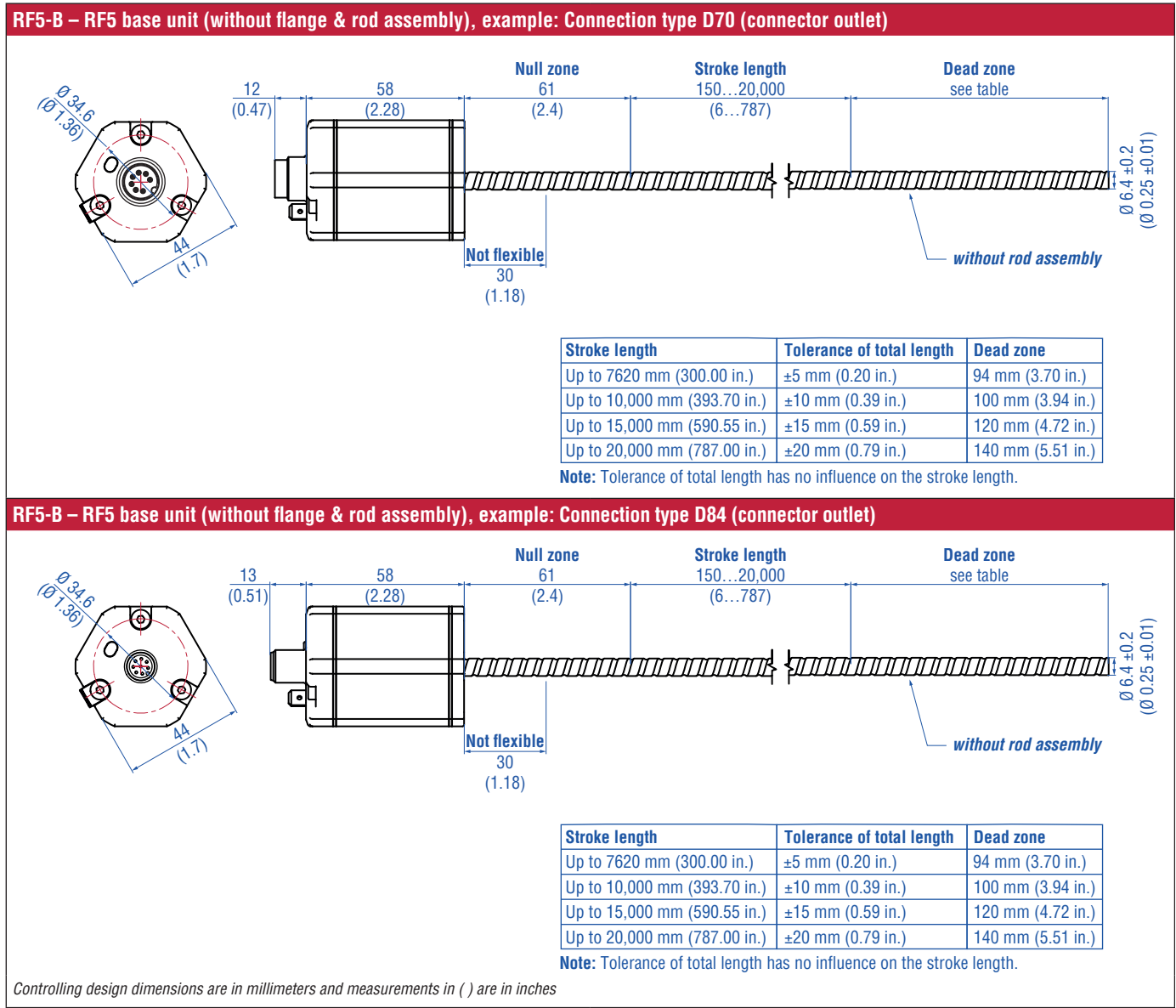
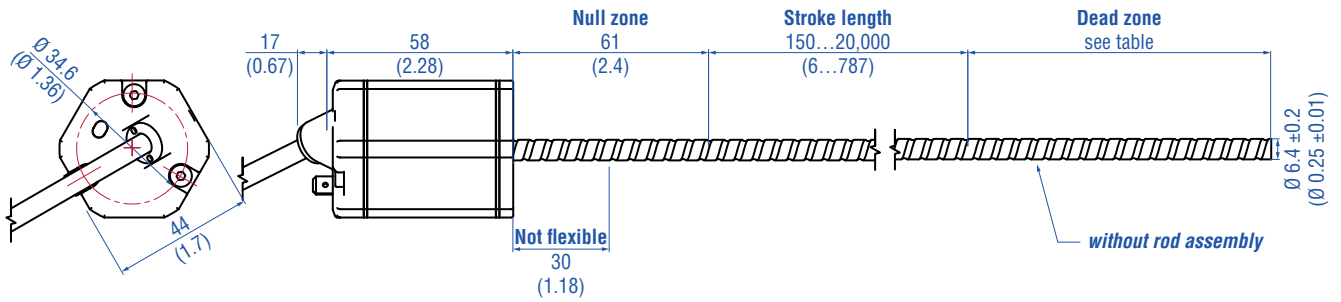

Fig. 2: Temposonics® RF5, part 1

RF5-B – RF5 base unit (without flange & rod assembly), example: Connection type BXX/EXX/GXX/LXX/UXX (angled cable outlet)



Stroke length	Tolerance of total length	Dead zone
Up to 7620 mm (300.00 in.)	±5 mm (0.20 in.)	94 mm (3.70 in.)
Up to 10,000 mm (393.70 in.)	±10 mm (0.39 in.)	100 mm (3.94 in.)
Up to 15,000 mm (590.55 in.)	±15 mm (0.59 in.)	120 mm (4.72 in.)
Up to 20,000 mm (787.00 in.)	±20 mm (0.79 in.)	140 mm (5.51 in.)

Note: Tolerance of total length has no influence on the stroke length.

RF5-B – RF5 base unit (without flange & rod assembly), example: Connection type HXX/PXX/RXX/TXX (straight cable outlet)

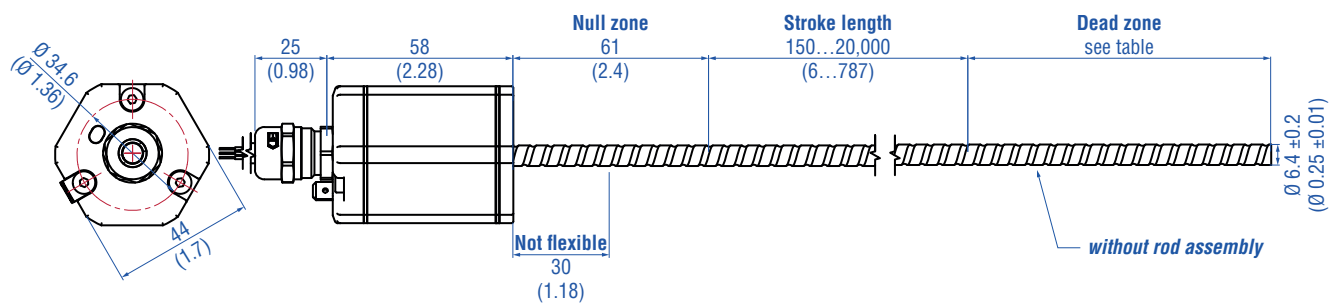

Stroke length	Tolerance of total length	Dead zone
Up to 7620 mm (300.00 in.)	±5 mm (0.20 in.)	94 mm (3.70 in.)
Up to 10,000 mm (393.70 in.)	±10 mm (0.39 in.)	100 mm (3.94 in.)
Up to 15,000 mm (590.55 in.)	±15 mm (0.59 in.)	120 mm (4.72 in.)
Up to 20,000 mm (787.00 in.)	±20 mm (0.79 in.)	140 mm (5.51 in.)

Note: Tolerance of total length has no influence on the stroke length.

Controlling design dimensions are in millimeters and measurements in () are in inches

Fig. 3: Temposonics® RF5, part 2

CONNECTOR WIRING

D70		
Signal + power supply		
M16 male connector	Pin	Function
 <p>View on sensor</p>	1	Data (-)
	2	Data (+)
	3	Clock (+)
	4	Clock (-)
	5	+12...30 VDC (±20 %)
	6	DC Ground (0 V)
	7	Not connected

Fig. 4: Connector wiring D70

HXX or LXX/PXX or BXX/RXX or EXX/TXX or GXX/UXX		
Signal + power supply		
Cable	Color	Function
	GY	Data (-)
	PK	Data (+)
	YE	Clock (+)
	GN	Clock (-)
	BN	+12...30 VDC (±20 %)
	WH	DC Ground (0 V)

For cable type TXX, the extra red & blue wires are not used.

Fig. 6: Connector wiring cable outlet

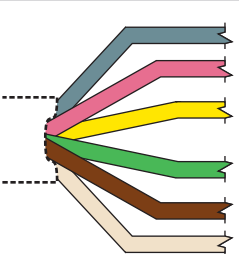

D84		
Signal + power supply		
M12 male connector (A-coded)	Pin	Function
 <p>View on sensor</p>	1	Clock (+)
	2	Clock (-)
	3	Data (+)
	4	Data (-)
	5	Not connected
	6	Not connected
	7	+12...30 VDC (±20 %)
	8	DC Ground (0 V)

Fig. 5: Connector wiring D84



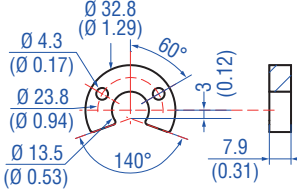
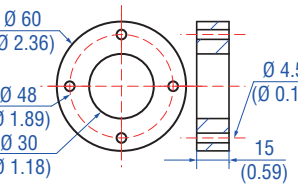
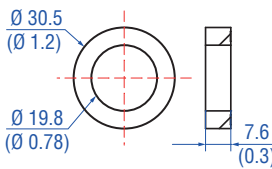
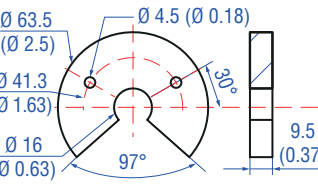
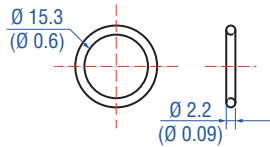
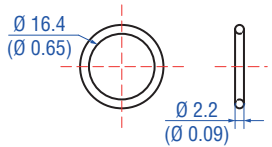
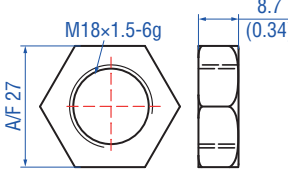
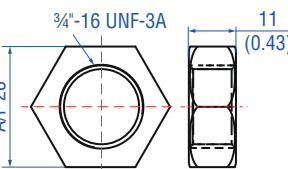

Straight cable outlet		Cable type		Angled cable outlet	
H	X X	Part no. 530 052	PUR	→	L X X Part no. 530 052
P	X X	Part no. 530 175	PUR	→	B X X Part no. 530 175
R	X X	Part no. 530 032	PVC	→	E X X Part no. 530 032
T	X X	Part no. 530 112	FEP	→	G X X Part no. 530 157

Fig. 7: Cable types assignment

FREQUENTLY ORDERED ACCESSORIES – Additional options available in our [Accessories Catalog](#) 551444

Position magnets			
			
<p>U-magnet OD33 Part no. 251416-2</p>	<p>Ring magnet OD60 Part no. MT0162</p>	<p>Ring magnet Part no. 402 316</p>	<p>U-magnet OD63.5 Part no. 201 553</p>
<p>Material: PA ferrite GF20 Weight: Approx. 11 g Surface pressure: Max. 40 N/mm² Fastening torque for M4 screws: 1 Nm Operating temperature: -40...+105 °C (-40...+221 °F)</p>	<p>Material: AlCuMgPb, magnets compound-filled Weight: Approx. 90 g Surface pressure: Max. 20 N/mm² Fastening torque for M4 screws: 1 Nm Operating temperature: -40...+75 °C (-40...+167 °F)</p>	<p>Material: PA ferrite coated Weight: Approx. 13 g Surface pressure: Max. 20 N/mm² Operating temperature: -40...+100 °C (-40...+212 °F)</p>	<p>Material: PA 66-GF30, magnets compound-filled Weight: Approx. 26 g Surface pressure: 20 N/mm² Fastening torque for M4 screws: 1 Nm Operating temperature: -40...+75 °C (-40...+167 °F)</p>
O-rings		Mounting accessories	
			
<p>O-ring for threaded flange M18x1.5-6g Part no. 401 133</p>	<p>O-ring for threaded flange 3/4-16 UNF-3A Part no. 560 315</p>	<p>Hex jam nut M18x1.5-6g Part no. 500 018</p>	<p>Hex jam nut 3/4-16 UNF-3A Part no. 500 015</p>
<p>Material: Fluoroelastomer Durometer: 75 ±5 Shore A Operating temperature: -40...+204 °C (-40...+400 °F)</p>	<p>Material: Fluoroelastomer Durometer: 75 ±5 Shore A Operating temperature: -40...+204 °C (-40...+400 °F)</p>	<p>Material: Steel, zinc plated</p>	<p>Material: Steel, zinc plated</p>
Mounting accessories			
			
<p>Threaded flange M18x1.5-6g Part no. 404 874</p> <p>Material: Stainless steel 1.4305 (AISI 303) Order O-rings separately: O-ring 15x2: Part no. 560 853 O-ring 15.3x2.2: Part no. 401 133</p>	<p>Threaded flange 3/4-16 UNF-3A Part no. 404 875</p> <p>Material: Stainless steel 1.4305 (AISI 303) Order O-rings separately: O-ring 15x2: Part no. 560 853 O-ring 16.4x2.2: Part no. 560 315</p>		



Mounting accessories

			
<p>Sensor rod with threaded flange with flat-face (M18x1.5-6g) and O-ring HD [length mm: XXXX] M HD [length in.: XXX.X] U</p>	<p>Sensor rod with threaded flange with flat-face (3/4"-16 UNF-3A) and O-ring HL [length mm: XXXX] M HL [length in.: XXX.X] U</p>	<p>Sensor rod with threaded flange with raised-face (3/4"-16 UNF-3A) and O-ring HP [length mm: XXXX] M HP [length in.: XXX.X] U</p>	<p>Profile with flange HFP [length mm: XXXXX] M HFP [length in.: XXXX.X] U</p>
<p>Pressure rod Ø: 12.7 mm (0.5 in.) Length: 100...7500 mm (4...295 in.) Operating pressure: 350 bar (5076 psi) Material flange: Stainless steel 1.4305 (AISI 303) Material rod: Stainless steel 1.4301 (AISI 304)</p>	<p>Pressure rod Ø: 12.7 mm (0.5 in.) Length: 100...7500 mm (4...295 in.) Operating pressure: 350 bar (5076 psi) Material flange: Stainless steel 1.4305 (AISI 303) Material rod: Stainless steel 1.4301 (AISI 304)</p>	<p>Pressure rod Ø: 12.7 mm (0.5 in.) Length: 100...7500 mm (4...295 in.) Operating pressure: 350 bar (5076 psi) Material flange: Stainless steel 1.4305 (AISI 303) Material rod: Stainless steel 1.4301 (AISI 304)</p>	<p>Length: Max. 20,000 mm (max. 787 in.) Ingress protection: IP30 Material: Aluminum</p>

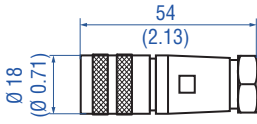
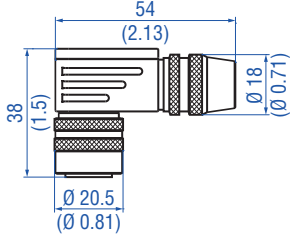
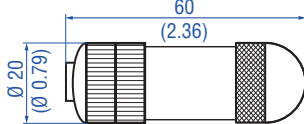
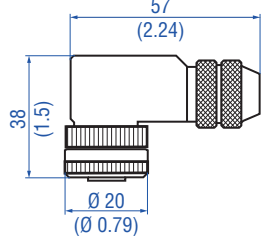

Cable connectors*

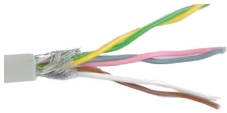
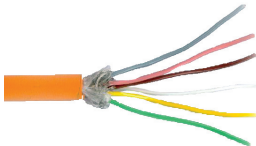
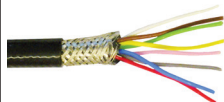

			
<p>M16 female connector (7 pin), straight Part no. 370 624</p>	<p>M16 female connector (7 pin), angled Part no. 560 779</p>	<p>M12 A-coded female connector (8 pin), straight Part no. 370 694</p>	<p>M12 A-coded female connector (8 pin), angled Part no. 370 699</p>
<p>Material: Zinc nickel plated Termination: Solder Contact insert: Silver plated Cable clamp: PG9 Cable Ø: 6...8 mm (0.24...0.31 in.) Operating temperature: -40...+100 °C (-40...+212 °F) Ingress protection: IP65/IP67 (correctly fitted) Fastening torque: 0.7 Nm</p>	<p>Material: Zinc nickel plated Termination: Solder Contact insert: Silver plated Cable clamp: PG9 Cable Ø: 6...8 mm (0.24...0.31 in.) Operating temperature: -40...+100 °C (-40...+212 °F) Ingress protection: IP65/IP67 (correctly fitted) Fastening torque: 0.7 Nm</p>	<p>Housing: GD-ZnAL Termination: Screw Contact insert: CuZn Cable Ø: 4...9 mm (0.16...0.35 in.) Wire: 0.75 mm² Operating temperature: -25...+90 °C (-13...+194 °F) Ingress protection: IP67 (correctly fitted) Fastening torque: 0.6 Nm</p>	<p>Housing: GD-ZnAL Termination: Screw Contact insert: CuZn Cable Ø: 6...8 mm (0.24...0.31 in.) Wire: 0.5 mm² Operating temperature: -25...+85 °C (-13...+185 °F) Ingress protection: IP67 (correctly fitted) Fastening torque: 0.6 Nm</p>

Cables

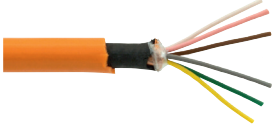
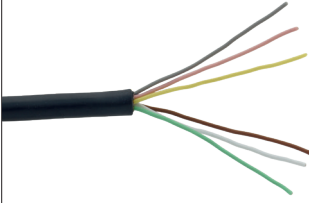
			
<p>PVC cable Part no. 530 032</p>	<p>PUR cable Part no. 530 052</p>	<p>FEP cable Part no. 530 112</p>	<p>FEP cable Part no. 530 157</p>
<p>Material: PVC jacket; gray Features: Twisted pair, shielded, flexible Cable Ø: 6 mm (0.23 in.) Cross section: 3 × 2 × 0.14 mm² Bending radius: 10 × D (fixed installation) Operating temperature: -40...+105 °C (-40...+221 °F)</p>	<p>Material: PUR jacket; orange Features: Twisted pair, shielded, highly flexible, halogen free, suitable for drag chains, mostly oil & flame resistant Cable Ø: 6.4 mm (0.25 in.) Cross section: 3 × 2 × 0.25 mm² Bending radius: 5 × D (fixed installation) Operating temperature: -20...+80 °C (-4...+176 °F)</p>	<p>Material: FEP jacket; black Features: Twisted pair, shielded, flexible, high thermal resistance, mostly oil & acid resistant Cable Ø: 7.6 mm (0.3 in.) Cross section: 4 × 2 × 0.25 mm² Bending radius: 8 – 10 × D (fixed installation) Operating temperature: -100...+180 °C (-148...+356 °F)</p>	<p>Material: FEP jacket; black Features: Twisted pair, shielded Cable Ø: 6.7 mm (0.26 in.) Cross section: 3 × 2 × 0.14 mm² Operating temperature: -40...+180 °C (-40...+356 °F)</p>

*/ Follow the manufacturer's mounting instructions
Controlling design dimensions are in millimeters and measurements in () are in inches
Color of connectors and cable jacket may change. Color codes for the individual wires and technical properties remain unchanged.

Cables		Cable sets	
			
<p>PUR cable Part no. 530 175</p> <p>Material: PUR jacket; orange Features: Flexible, additional EMC protection Cable Ø: 6.5 mm (0.26 in.) Cross section: 6 × 0.14 mm² Bending radius: 10 × D (fixed installation) Operating temperature: -30...+90 °C (-22...+194 °F)</p>	<p>Silicone cable Part no. 530 176</p> <p>Material: Silicone jacket; black Features: Twisted pair, shielded Cable Ø: 6.3 mm (0.25 in.) Cross section: 3 × 2 × 0.14 mm² Bending radius: 7 × D (fixed installation) Operating temperature: -50...+150 °C (-58...+302 °F)</p>	<p>Cable with M12 A-coded female connector (8 pin), straight – pigtail Part no. 370 674</p> <p>Material: PUR jacket; black Feature: Shielded Cable length: 5 m (16.4 ft) Ingress protection: IP67/IP69K (correctly fitted) Operating temperature: -25...+80 °C (-13...+176 °F)</p>	<p>Cable with M12 A-coded female connector (8 pin), angled – pigtail Part no. 370 676</p> <p>Cable: Shielded Cable length: 5 m (16.4 ft) Ingress protection: IP67 (correctly fitted)</p>

Programming tools	
	
<p>TempoLink® kit for Temposonics® R-Series V Part no. TL-1-0-SD70 (for D70) Part no. TL-1-0-SD84 (for D84) Part no. TL-1-0-AS00 (for cable outlet)</p> <ul style="list-style-type: none"> • Connect wirelessly via Wi-Fi enabled device or via USB with the diagnostic tool • Simple connectivity to the sensor via 24 VDC power line (permissible cable length: 30 m) • User friendly interface for mobile devices and desktop computers • See data sheet “TempoLink® smart assistant” (document part no.: 552070) for further information 	<p>TempoGate® smart assistant for Temposonics® R-Series V Part no. TG-C-0-Dxx (xx indicates the number of R-Series V sensors that can be connected (even numbers only))</p> <ul style="list-style-type: none"> • OPC UA server for diagnostics of the R-Series V • For installation in the control cabinet • Connection via LAN and Wi-Fi • See data sheet “TempoGate® smart assistant” document part no.: 552110 for further information

Color of connectors and cable jacket may change. Color codes for the individual wires and technical properties remain unchanged.

ORDER CODE

1	2	3	4	5	6	7	8	9	10	11	12	13	14	15	16	17	18	19	20	21	22	23	24	25	26	27	
R	F	5													1	S		0									
a			b	d						e	f			g	h	i	j	k	l	m	n	o					
optional																											

a Sensor model

R	F	5	Improved flexible rod
---	---	---	-----------------------

b Design

B	Base unit (without flange & rod assembly)
---	-------------------------------------------

Section **c** is intentionally omitted.

d Stroke length

X	X	X	X	X	M	00150...20000 mm
---	---	---	---	---	---	------------------

Stroke length (mm)	Ordering steps
150... 1000 mm	50 mm
1000... 5000 mm	100 mm
5000... 10000 mm	250 mm
10000... 15000 mm	500 mm
15000... 20000 mm	1000 mm

X	X	X	X	X	U	0006.0...0787.0 in.
---	---	---	---	---	---	---------------------

Stroke length (in.)	Ordering steps
6... 40 in.	2 in.
40... 197 in.	4 in.
197... 394 in.	10 in.
394... 591 in.	20 in.
591... 787 in.	40 in.

Non standard stroke lengths are available; must be encoded in 5 mm/0.1 in. increments

e Number of magnets

X	X	01...02 position(s) (1...2 magnet(s))
---	---	---------------------------------------

f Connection type

Connector

D	7	0	M16 male connector (7 pin)
---	---	---	----------------------------

D	8	4	M12 male connector (8 pin)
---	---	---	----------------------------

Angled cable outlet

B	X	X	XX m/ft. PUR cable (part no. 530 175) B01...B30 (1...30 m/3...99 ft.) (Note the temperature range of the cable!) See "Frequently ordered accessories" for cable specifications
---	---	---	-----------------------------------------------------------------------------------------------------------------------------------------------------------------------------------------

E	X	X	XX m/ft. PVC cable (part no. 530 032) E01...E30 (1...30 m/3...99 ft.) See "Frequently ordered accessories" for cable specifications
---	---	---	-------------------------------------------------------------------------------------------------------------------------------------------

G	X	X	XX m/ft. FEP cable (part no. 530 157) G01...G30 (1...30 m/3...99 ft.) See "Frequently ordered accessories" for cable specifications
---	---	---	-------------------------------------------------------------------------------------------------------------------------------------------

L	X	X	XX m/ft. PUR cable (part no. 530 052) L01...L30 (1...30 m/3...99 ft.) (Note the temperature range of the cable!) See "Frequently ordered accessories" for cable specifications
---	---	---	-----------------------------------------------------------------------------------------------------------------------------------------------------------------------------------------

U	X	X	XX m/ft. Silicone cable (part no. 530 176) U01...U30 (1...30 m/3...99 ft.) See "Frequently ordered accessories" for cable specifications
---	---	---	------------------------------------------------------------------------------------------------------------------------------------------------

Straight cable outlet

H	X	X	XX m/ft. PUR cable (part no. 530 052) H01...H30 (1...30 m/3...99 ft.) (Note the temperature range of the cable!) See "Frequently ordered accessories" for cable specifications
---	---	---	-----------------------------------------------------------------------------------------------------------------------------------------------------------------------------------------

P	X	X	XX m/ft. PUR cable (part no. 530 175) P01...P30 (1...30 m/3...99 ft.) (Note the temperature range of the cable!) See "Frequently ordered accessories" for cable specifications
---	---	---	-----------------------------------------------------------------------------------------------------------------------------------------------------------------------------------------

R	X	X	XX m/ft. PVC cable (part no. 530 032) R01...R30 (1...30 m/3...99 ft.) See "Frequently ordered accessories" for cable specifications
---	---	---	-------------------------------------------------------------------------------------------------------------------------------------------

T	X	X	XX m/ft. FEP cable (part no. 530 112) T01...T30 (1...30 m/3...99 ft.) See "Frequently ordered accessories" for cable specifications
---	---	---	-------------------------------------------------------------------------------------------------------------------------------------------

Encode in meters if using metric stroke length.
Encode in feet if using US customary stroke length.

Temposonics® R-Series V RF5 SSI

Data Sheet

g System	
1	Standard

h Output	
S	SSI

i Function	
1	Position
2	Differential measurement (2 magnets and 1 output)
3	Velocity
4	Position and temperature in the sensor electronics housing; NOTICE In this case, only option 2 "24 bit" can be selected under l "Data length".

j Options	
0	Standard

k Mode	
1	Measuring direction forward, asynchronous mode
2	Measuring direction forward, synchronous mode 1
3	Measuring direction forward, synchronous mode 2
4	Measuring direction forward, synchronous mode 3
5	Measuring direction reverse, asynchronous mode
6	Measuring direction reverse, synchronous mode 1
7	Measuring direction reverse, synchronous mode 2
8	Measuring direction reverse, synchronous mode 3

l Data length*	
1	25 bit
2	24 bit
3	26 bit
A	24 bit + alarm bit + parity bit

m Format	
B	Binary
G	Gray

n Resolution	
1	5 µm
2	10 µm
3	50 µm
4	100 µm
5	20 µm
6	2 µm
7	0.1 µm*
8	1 µm
9	0.5 µm

o Additional options (optional)				
S	0	0	2	FIR filter (2 measurements)
S	0	0	4	FIR filter (4 measurements)
S	0	0	8	FIR filter (8 measurements)
S	0	0	A	No filter, error counter (4 cycles)
S	0	0	C	No filter, error counter (8 cycles)
S	0	0	D	No filter, error counter (10 cycles)
S	0	0	G	FIR filter (8 measurements), error counter (10 cycles)
S	0	0	J	IIR filter (filter grade 4)
S	0	0	K	IIR filter (filter grade 8)
S	0	0	N	IIR filter (filter grade 8), error counter (10 cycles)

NOTICE

- Specify the number of magnets for your application and order the magnets separately.
- The number of magnets is limited by the stroke length. The minimum allowed distance between magnets (i.e. front face of one to the front face of the next one) is 75 mm (3 in.).
- Use magnets of the same type for differential measurement.
- The sensor is without rod assembly. Always insert the flexible sensor rod in a support tube (e.g. sensor rod HD/HL/HP or HFP profile).

DELIVERY



RF5-B:

- Base unit (without flange & rod assembly)
- 3 × socket screws M4×59

Accessories have to be ordered separately.

*/ The stroke length of the sensor influences the choice of resolution and data width. See glossary under "Resolution and data width depending on stroke length"

Manuals, Software & 3D Models available at:
www.temposonics.com

GLOSSARY

A
<p>Alarm The alarm bit is set by the sensor if the sensor detects more magnets (extra magnet) or less magnets (magnet status error) than configured.</p> <p>Asynchronous mode In asynchronous mode the position data is continuously updated inside the sensor as quickly as the sensor's measurement cycle will allow, independent of the controller. The controller's loop time will determine when the sensor's most recent data is clocked out over the SSI interface. (→ Synchronous mode)</p>
D
<p>Differential measurement For differential measurement, the distance between the two position magnets is output as a value.</p>
E
<p>Extrapolation The native measurement cycle time of a sensor increases with the stroke length. With extrapolation, the sensor is able to report data faster than the native cycle time, independent of the stroke length of the sensor. Without extrapolation, if data is requested faster than the native cycle time, the last measured value is repeated.</p>
F
<p>FIR filter The FIR filter (Finite Impulse Response) is used to smooth the measured position value before output. To determine the output value, only input values corresponding to the window (filter window size) are used for filter calculation. The output value is calculated from these input values in the form of a moving average value. (→ IIR Filter)</p>
I
<p>IIR filter The IIR filter (Infinite Impulse Response) is used to smooth the measured position value before output. To determine the output value, the input values corresponding to the filter grade (filter window size) are used for the filter calculation. The previous values are also taken into account when calculating the output value. (→ FIR Filter)</p>
M
<p>Measuring direction When moving the position magnet, the position and velocity values increase in the measuring direction.</p> <ul style="list-style-type: none"> • Forward: Values increasing from sensor electronics housing to rod end/profile end • Reverse: Values decreasing from sensor electronics housing to rod end/profile end

P
<p>Parity The parity bit is a check bit that is added to a bit string to detect transmission errors. There are even parity and odd parity. With even parity, the parity bit is set so that the total number of 1-bits in the bit string including the parity bit is even. In case of odd parity, the total number of 1-bits in the bit sequence including the parity bit is odd. Even parity is implemented in the R-Series V SSI.</p>
R
<p>Resolution and data length depending on stroke length The stroke length of the sensor influences the choice of resolution and data length. The resolution (step size) and data length (number of steps) must be selected so that the stroke length is covered. For example, with a data length of 24 bit and a resolution of 0.5 µm for an RH5 sensor the maximum stroke length of 7620 mm can be represented. You can adjust the resolution and the data length of the R-Series V SSI via the TempoLink® and TempoGate® smart assistants.</p>
S
<p>Synchronous Serial Interface SSI (Synchronous Serial Interface) is a digital interface where the data is transferred serially. The interface of R-Series V SSI corresponds to SSI industry standard for absolute encoders. Its displacement value is encoded in a 24/25/26 bit binary or gray format and transmitted as a differential signal in SSI standard (RS-485/RS-422).</p> <p>Synchronous mode In synchronous mode the measurement and output of the sensor is matched to the data request cycle of the controller. The synchronous mode minimizes the time delay between measurement and output. The synchronous mode is required for sophisticated motion control applications. (→ Asynchronous mode)</p> <ul style="list-style-type: none"> • Synchronous mode 1 Using synchronous mode 1, the sensor determines the controller's loop timing and when data is being requested. The sensor then determines when to start the next measurement cycle so that it will complete just in time to deliver the freshest data possible. • Synchronous mode 2 If new position data is required faster than the sensor's measurement cycle time, synchronous mode 2 provides extrapolated data values, calculated on the fly. A measurement value will be calculated and output to the controller whenever the sensor has not yet completed the next measurement cycle. • Synchronous mode 3 Synchronous mode 3 provides an extrapolation to the high speed update feature of synchronous mode 2. For this mode all measurements values which are output are calculated to fully compensate for the inherent lag time due to the sensor's measurement cycle. (→ Extrapolation)
T
<p>Temperature in the sensor electronics housing The temperature in the sensor electronics housing is measured in °C. With this option, the transmitted data word has a length of 32 bits, with the highest 8 bits representing the temperature value, followed by 24 bits for the position value. The temperature value is coded in the same format as the position value.</p>

UNITED STATES
Temposonics, LLC
Americas & APAC Region
3001 Sheldon Drive
Cary, N.C. 27513
Phone: +1 919 677-0100
E-mail: info.us@temposonics.com

GERMANY
Temposonics
GmbH & Co. KG
EMEA Region & India
Auf dem Schüffel 9
58513 Lüdenscheid
Phone: +49 2351 9587-0
E-mail: info.de@temposonics.com

ITALY
Branch Office
Phone: +39 030 988 3819
E-mail: info.it@temposonics.com

FRANCE
Branch Office
Phone: +33 6 14 060 728
E-mail: info.fr@temposonics.com

UK
Branch Office
Phone: +44 79 21 83 05 86
E-mail: info.uk@temposonics.com

SCANDINAVIA
Branch Office
Phone: +46 70 29 91 281
E-mail: info.sca@temposonics.com

CHINA
Branch Office
Phone: +86 21 3405 7850
E-mail: info.cn@temposonics.com

JAPAN
Branch Office
Phone: +81 3 6416 1063
E-mail: info.jp@temposonics.com

Document Part Number:
552207 Revision A (EN) 12/2024



temposonics.com