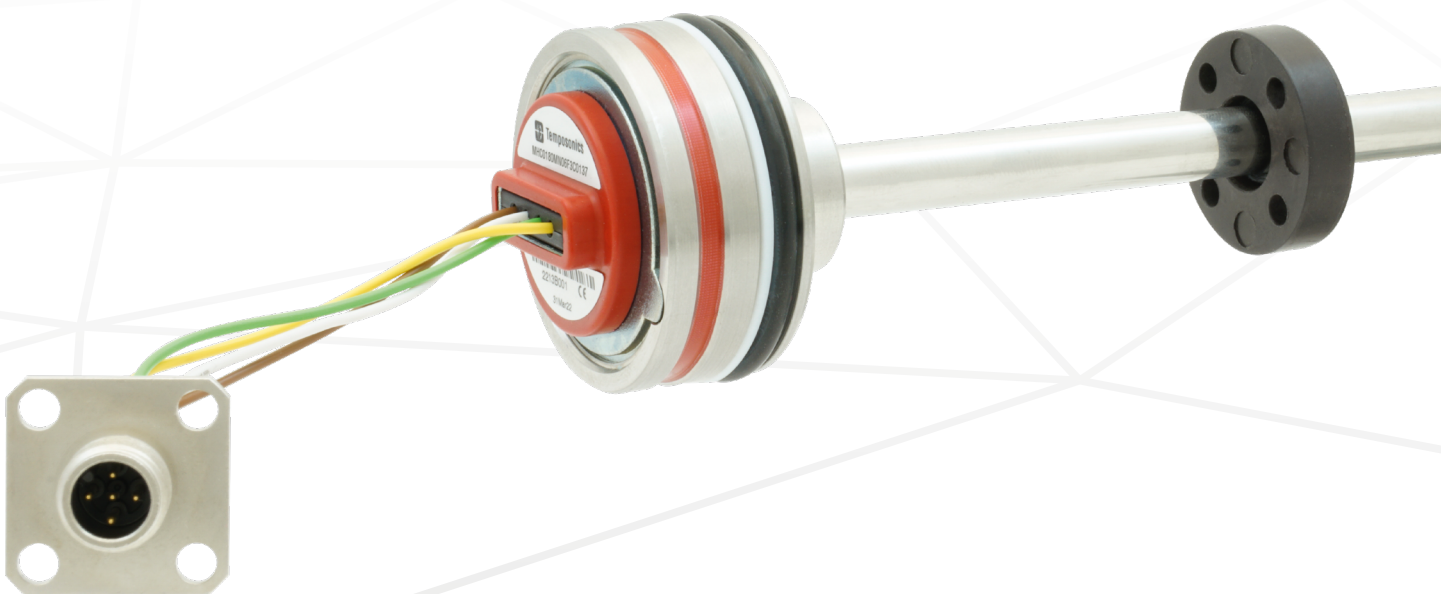


## Data Sheet

# MH-Series MH4 Plus CANbus

## Magnetostrictive Linear Position Sensors

- Stroke length up to 2500 mm
- Linearity < 0.04 % F.S. / Resolution typ. 0.1 mm
- High reliability due to EMC, shock & vibration resistance



## MEASURING TECHNOLOGY

The absolute, linear position sensors provided by Temposonics rely on the company's proprietary magnetostrictive technology, which can determine position with a high level of precision and robustness. Each Temposonics position sensor consists of a ferromagnetic waveguide, a position magnet, a strain pulse converter and a supporting electronics. The magnet, connected to the object in motion in the application, generates a magnetic field at its location on the waveguide. A short current pulse is applied to the waveguide. This creates a momentary radial magnetic field and torsional strain on the waveguide. The momentary interaction of the magnetic fields releases a torsional strain pulse that propagates the length of the waveguide. When the ultrasonic wave reaches the beginning of the waveguide it is converted into an electrical signal. Since the speed of the ultrasonic wave in the waveguide is precisely known, the time required to receive the return signal can be converted into a linear position measurement with both high accuracy and repeatability.

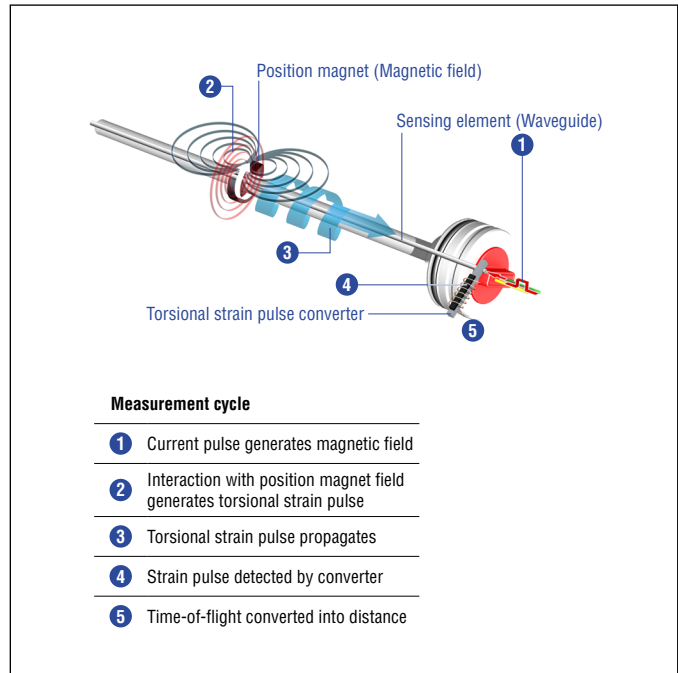


Fig. 1: Time-of-flight based magnetostrictive position sensing principle

## MH SENSOR

Temposonics® sensors can be used in versatile mobile machines without any restriction and replace contact-based linear sensors like potentiometers. Highly dynamic systems are controlled safely by means of Temposonics® sensors, thus enhancing the productivity, availability and quality of the working process of the machine. Insensitive to vibration, shock, dust and weathering influence and electro-magnetic disturbances. Temposonics® MH sensors are successfully used in front axle and articulated frame steering cylinders, hydraulic jacks and in steering systems for hydraulic units on agricultural and construction machinery.

## DESIGNED FOR THE MOBILE WORLD

MH sensors are designed for mobile machines and intended for IN cylinder use. They are validated in the field by worldwide OEM's and replace linear potentiometers and inductive sensors.



Fig. 2: Typical applications

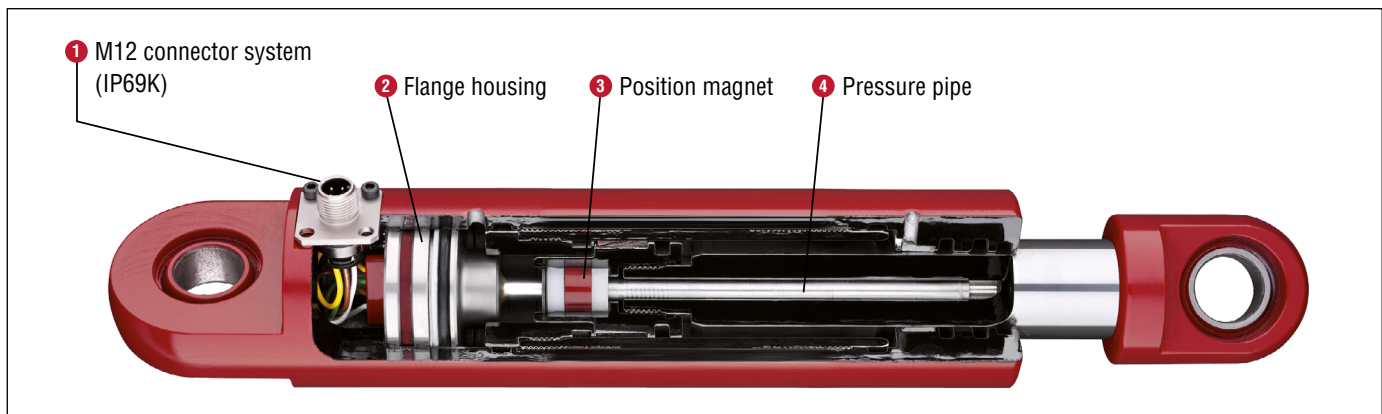


Fig. 3: IN cylinder installation

## TECHNICAL DATA

Output	
Bus-protocol	SAE J1939, CANopen protocol according to CiA DS-301 V4.1, device profile DS-406 V3.1
Measured value	Position and velocity
Measurement parameters	
Stroke length	50...2500 mm
Resolution (position)	0.1 mm
Resolution (velocity)	1 mm/s
Boot up Time	400 ms (typical)
Cycle Time	CANopen: 1 ms (default) SAE J1939: 20 ms (default)
Linearity	0050...0250 mm $\leq \pm 0.1$ mm 0255...2000 mm $\pm 0.04$ % (F.S.) 2005...2500 mm $\leq \pm 0.8$ mm
Internal sample rate	1 ms
Setpoint tolerance	$\pm 0.2$ mm
Operating conditions	
Operating temperature electronics	-40...+105 °C (Option: -40...+85 °C)
Humidity	90 % relative humidity, no condensation, EN 60068-2-30
Ingress protection - Connector	M12 connector: IP67/IP69K (connectors correctly fitted), EN 60529 DT connector system: IP67/IP69K (connectors correctly fitted), EN 60529
Ingress protection – Sensor housing	IP67, EN 60529
Shock	100 g (11 ms) single shock per axis, IEC 60068-2-27 50 g (11 ms) at 1000 shocks per axis, IEC 60068-2-29
Vibration	Operational sine vibration test IEC 60068-2-6: Ø 7 mm sensor rod: 15 g (5...2000 Hz)* Ø 10 mm sensor rod: 20 g (5...2000 Hz)* Survival random vibration test IEC 60068-2-64: 20 g RMS (20...2000 Hz) 12 h per axis*
EMC	Compliant with: ISO 13766-1:2018 Earth-moving and building construction machinery EN ISO 14982:2009 Agricultural and Forestry Machinery EN 13309:2010 Construction machinery ISO 16750-2:2012 Road vehicles
EMI	200 V/m (ISO 11452-2:2019 200...2000 MHz) 200 mA (ISO 11452-4:2011 20...200 MHz)
Operating pressure ratings	
	<b>Pressure (according to DIN EN ISO 19879)**</b>
PN (nominal operating)	Ø 7 mm sensor rod: 300 bar Ø 10 mm sensor rod: 350 bar
Pmax (max. overload)	Ø 7 mm sensor rod: 400 bar Ø 10 mm sensor rod: 450 bar
Pstatic (proof pressure)	Ø 7 mm sensor rod: 525 bar Ø 10 mm sensor rod: 625 bar
Design / Material	
Sensor electronics housing	Stainless steel 1.4305 (AISI 303)
Sealing	O-ring: HNBR 70
Sensor rod	Ø 7 mm sensor rod: Stainless steel 1.4301 (AISI 304) Ø 10 mm sensor rod: Stainless steel 1.4306 (AISI 304L)

\* / Resonance frequencies excluded

\*\* / According to calculations under use of the FKM guideline

Cycles	Ø 7 mm sensor rod	Ø 10 mm sensor rod
Dynamic pressure: $< 2 \times 10^6$ pressure cycles	300 bar	350 bar
Static pressure: $< 2 \times 10^4$ pressure cycles	400 bar	450 bar
Proof pressure: Maximum 5 minutes testing time for cylinder pressure test	525 bar	625 bar

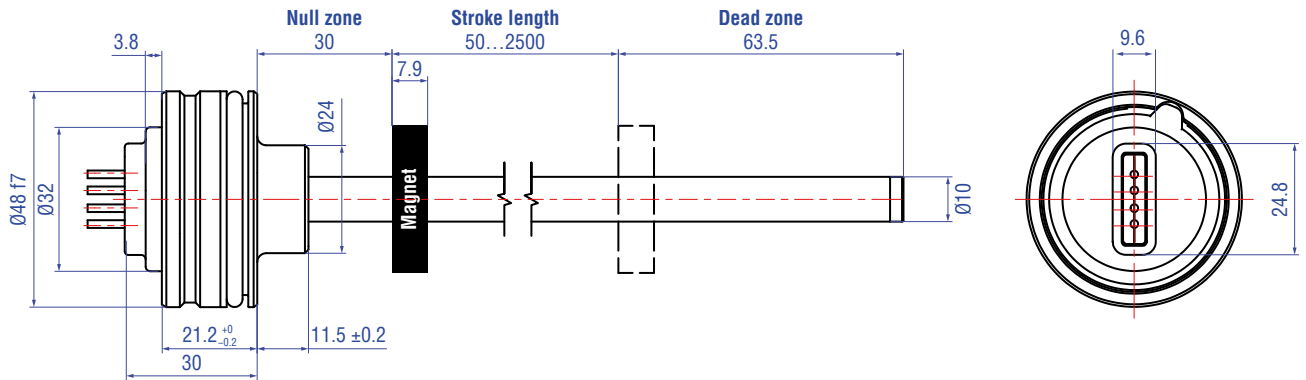
## Temposonics® MH-Series MH4 Plus CANbus

### Data Sheet

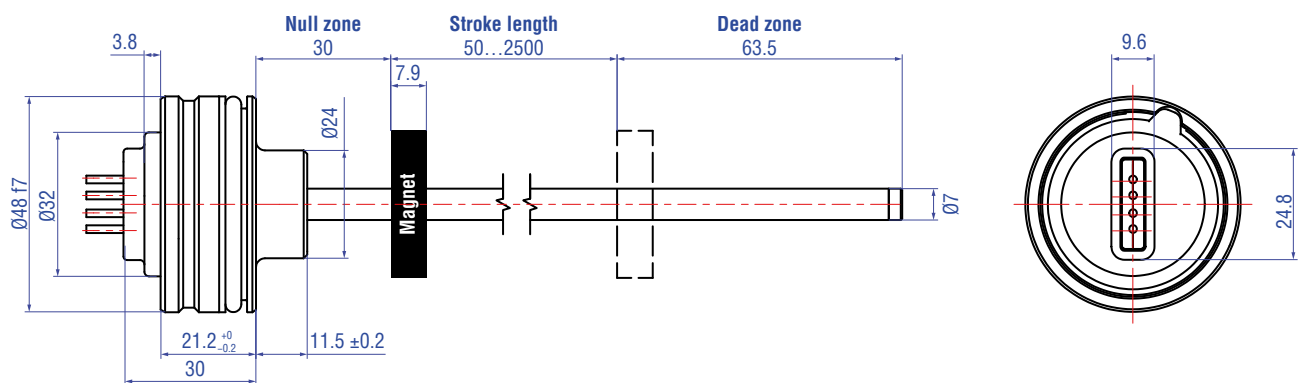
Electrical connection	
Connection type	M12 connector or DT connector system or single wires or cable output
Operating voltage	12/24 VDC nominal (8...32 VDC)
Max Inrush current	1.5 A/2 ms (1.0 A/2 ms if supply < 13 V)
Supply voltage ripple	< 1 % PP
Power drain	< 1.5 W
Bus termination (HI-LO)	120 $\Omega$
Over voltage protection (GND-VDC)	Up to +36 VDC
Polarity protection (GND-VDC)	Up to -36 VDC
Insulation Resistance	R $\geq$ 10 M $\Omega$ @ 60 sec
Electric strength	500 VDC (DC GND to chassis GND)

## TECHNICAL DRAWING

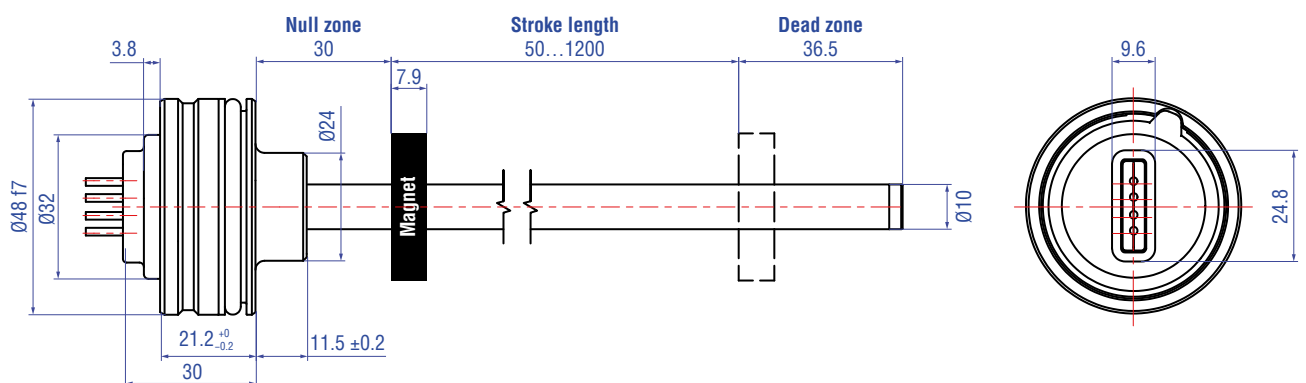
**MH-C – Rod: Ø 10 mm / Dead zone: 63.5 mm / Stroke length: 50...2500 mm**



**MH-D – Rod: Ø 7 mm / Dead zone: 63.5 mm / Stroke length: 50...2500 mm**



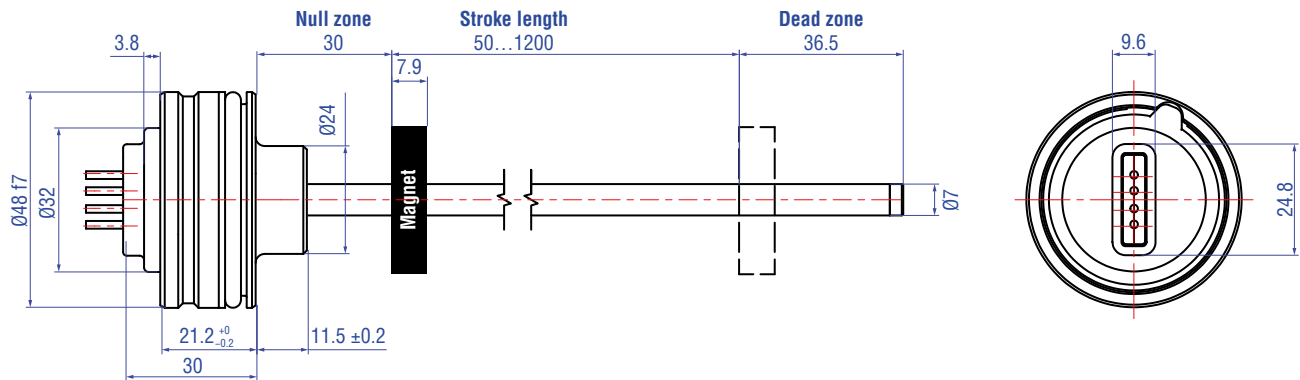
**MH-E – Rod: Ø 10 mm / Dead zone: 36.5 mm / Stroke length: 50...1200 mm**



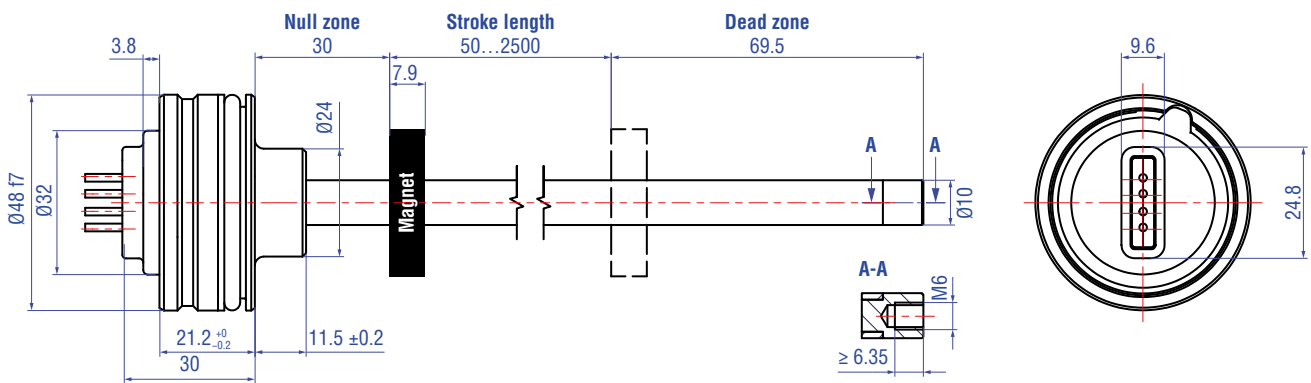
Controlling design dimensions are in millimeters

Fig. 4: Temposonics® MH-Series MH sensor, part 1

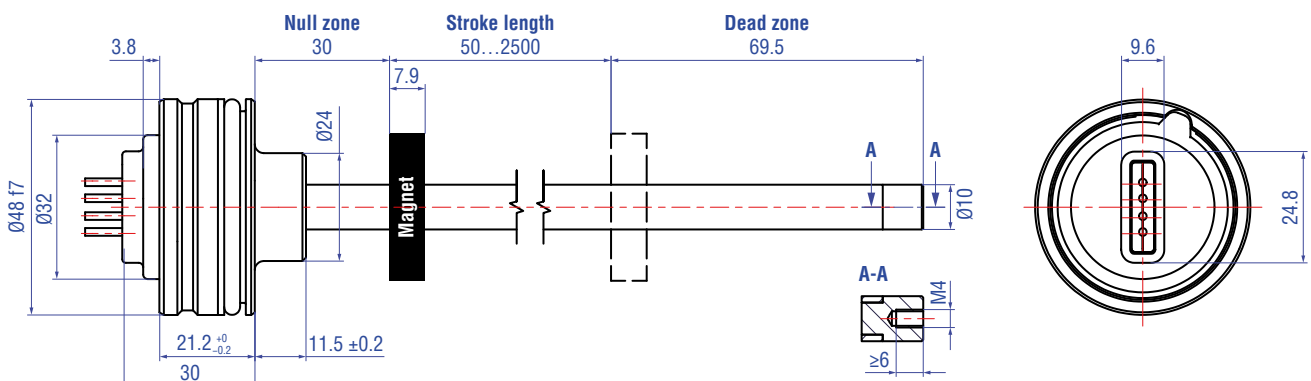
**MH-F – Rod: Ø 7 mm / Dead zone: 36.5 mm / Stroke length: 50...1200 mm**



**MH-L – Rod: Ø 10 mm + end plug with female M6 thread / Dead zone: 69.5 mm / Stroke length: 50...2500 mm**



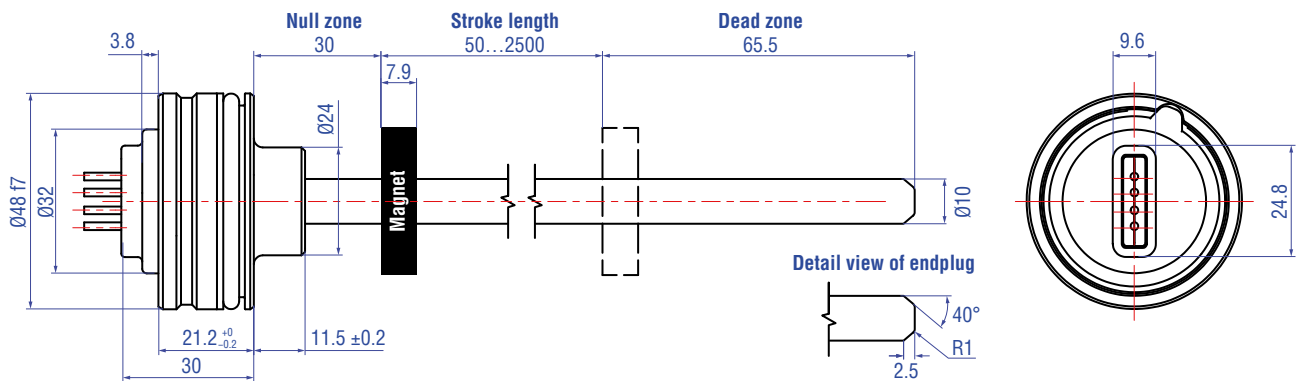
**MH-R – Rod: Ø 10 mm + end plug with female M4 thread / Dead zone: 69.5 mm / Stroke length: 50...2500 mm**



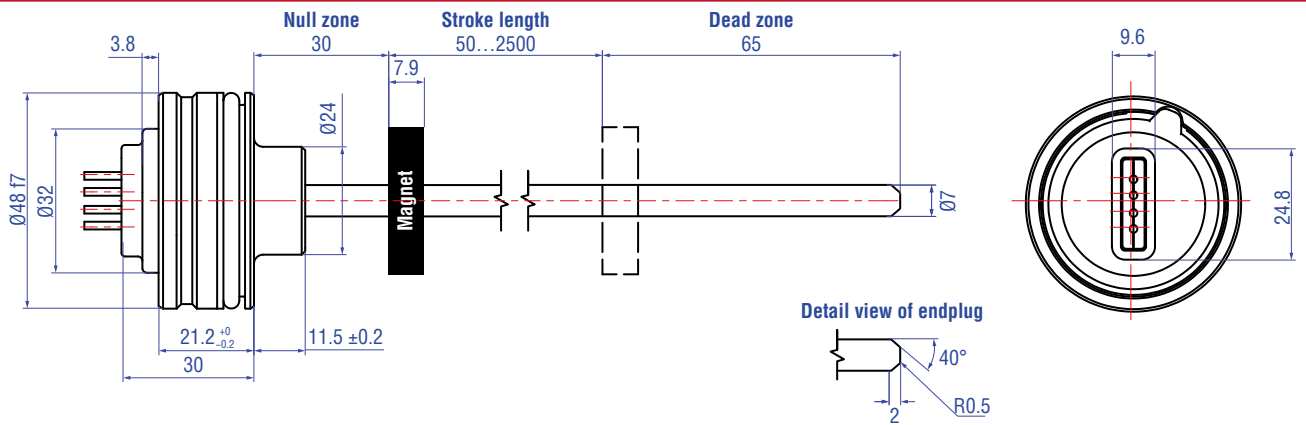
Controlling design dimensions are in millimeters

Fig. 5: Temposonics® MH-Series MH sensor, part 2

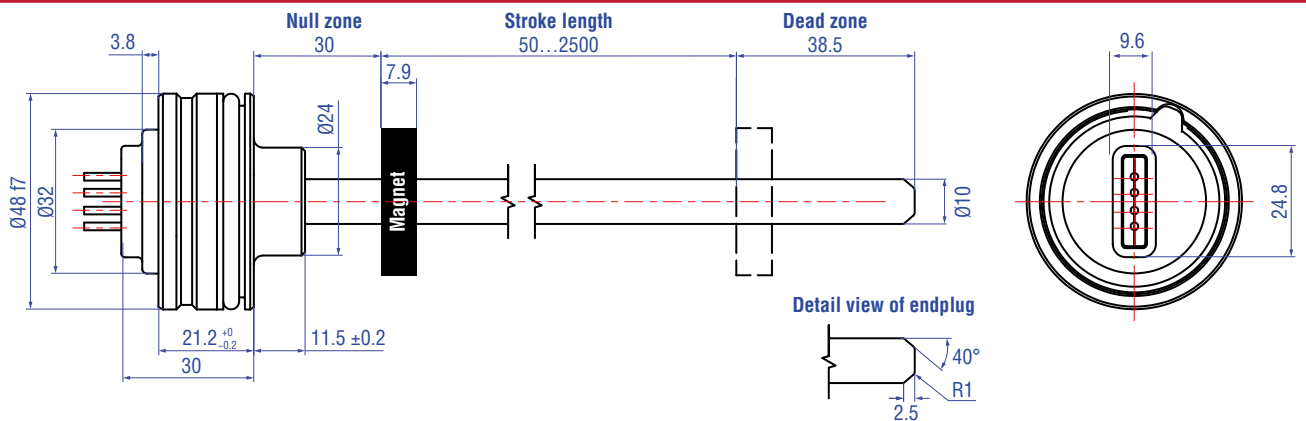
**MH-C with conical end plug "K1" for Ø 10 mm**



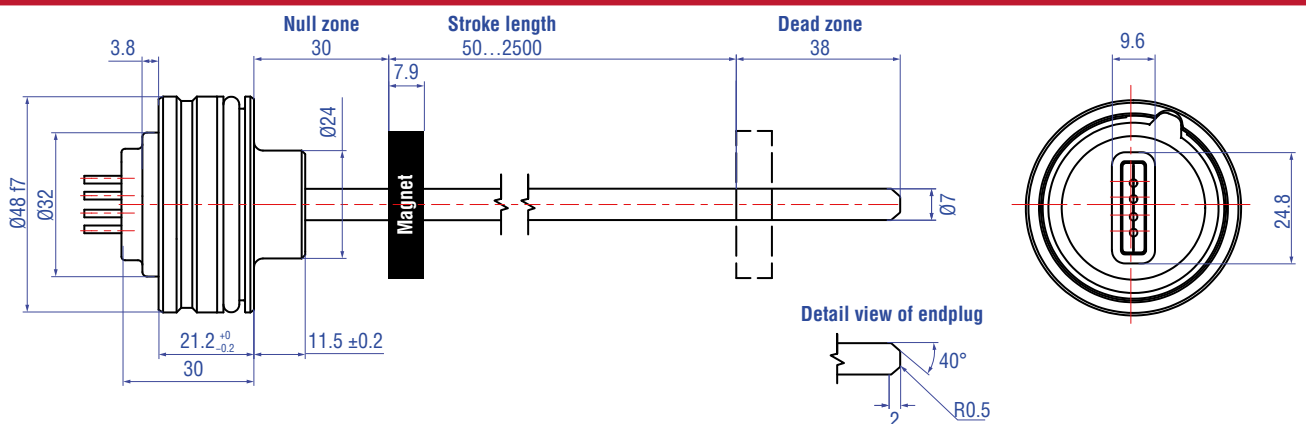
**MH-D with conical end plug "K1" for Ø 7 mm**



**MH-E with conical end plug "K1" for Ø 10 mm**



**MH-F with conical end plug "K1" for Ø 7 mm**



Controlling design dimensions are in millimeters

Fig. 6: Temposonics® MH-Series MH sensor, part 3

## CONNECTOR WIRING

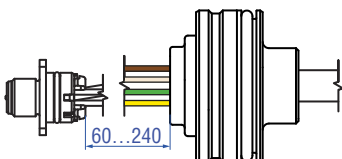

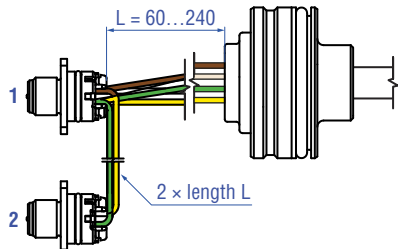
M12 connector (N...F)																																								
	<ul style="list-style-type: none"> <li>• Single lead wires 0.22 mm<sup>2</sup></li> <li>• Attached A-coded M12 connector attached</li> <li>• Toolless assembly</li> <li>• Sealing IP67, up to IP69K with plugged mating connector</li> </ul>																																							
	<p><b>Connector wiring</b></p> <table border="1"> <thead> <tr> <th>Pin</th> <th>Wire</th> <th>Function</th> </tr> </thead> <tbody> <tr> <td>1</td> <td>–</td> <td>not connected</td> </tr> <tr> <td>2</td> <td>BN</td> <td>VDC</td> </tr> <tr> <td>3</td> <td>WH</td> <td>GND</td> </tr> <tr> <td>4</td> <td>YE</td> <td>CAN_H</td> </tr> <tr> <td>5</td> <td>GN</td> <td>CAN_L</td> </tr> </tbody> </table> <p>View on connector</p> 	Pin	Wire	Function	1	–	not connected	2	BN	VDC	3	WH	GND	4	YE	CAN_H	5	GN	CAN_L																					
Pin	Wire	Function																																						
1	–	not connected																																						
2	BN	VDC																																						
3	WH	GND																																						
4	YE	CAN_H																																						
5	GN	CAN_L																																						
M12 dual connector (V...F)																																								
	<ul style="list-style-type: none"> <li>• Single lead wires 0.22 mm<sup>2</sup></li> <li>• Attached A-coded M12 connector attached</li> <li>• Toolless assembly</li> <li>• Sealing IP67, up to IP69K with plugged mating connector</li> <li>• Based on DIN EN 61076-2-101</li> </ul>																																							
	<p><b>Connector wiring</b></p> <table border="1"> <thead> <tr> <th>1</th> <th>Pin</th> <th>Wire</th> <th>Function</th> <th>2</th> <th>Pin</th> <th>Wire</th> <th>Function</th> </tr> </thead> <tbody> <tr> <td rowspan="5">View on connector</td> <td>1</td> <td>–</td> <td>not connected</td> <td rowspan="5">View on connector</td> <td>1</td> <td>–</td> <td>not connected</td> </tr> <tr> <td>2</td> <td>BN</td> <td>VDC</td> <td>2</td> <td>BN</td> <td>VDC</td> </tr> <tr> <td>3</td> <td>WH</td> <td>GND</td> <td>3</td> <td>WH</td> <td>GND</td> </tr> <tr> <td>4</td> <td>YE</td> <td>CAN_H</td> <td>4</td> <td>YE</td> <td>CAN_H</td> </tr> <tr> <td>5</td> <td>GN</td> <td>CAN_L</td> <td>5</td> <td>GN</td> <td>CAN_L</td> </tr> </tbody> </table>	1	Pin	Wire	Function	2	Pin	Wire	Function	View on connector	1	–	not connected	View on connector	1	–	not connected	2	BN	VDC	2	BN	VDC	3	WH	GND	3	WH	GND	4	YE	CAN_H	4	YE	CAN_H	5	GN	CAN_L	5	GN
1	Pin	Wire	Function	2	Pin	Wire	Function																																	
View on connector	1	–	not connected	View on connector	1	–	not connected																																	
	2	BN	VDC		2	BN	VDC																																	
	3	WH	GND		3	WH	GND																																	
	4	YE	CAN_H		4	YE	CAN_H																																	
	5	GN	CAN_L		5	GN	CAN_L																																	

Fig. 7: Connector wiring



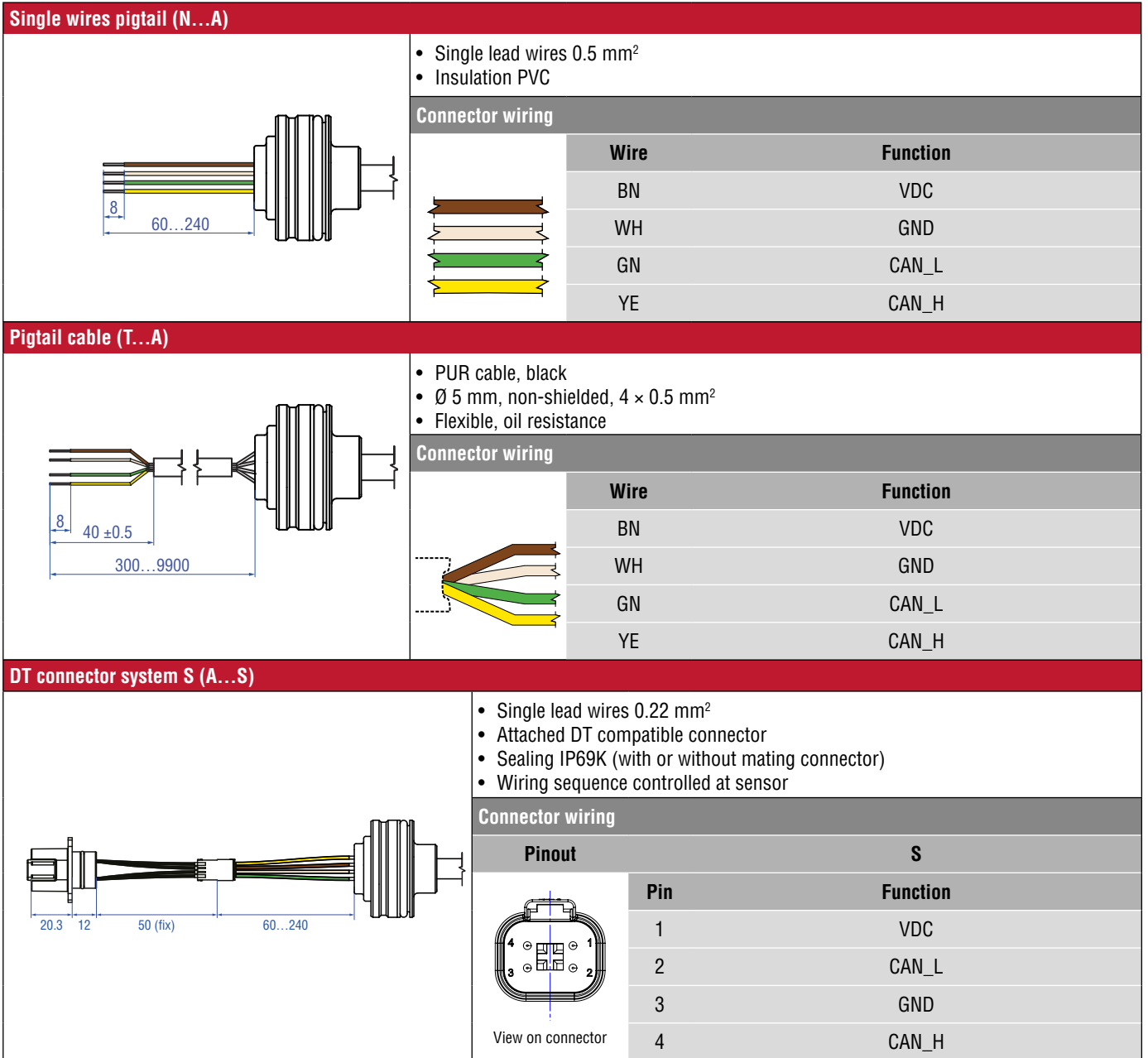


Fig. 8: Connector wiring

### Connection schematics

To ensure proper operation of the sensor, the hydraulic cylinder must be connected to the machine ground. Grounding is often ensured by the mechanical contact between the cylinder and other machine elements. If the cylinder is connected with the machine separately, separate grounding, for example via a grounding strap directly on the cylinder must be ensured.

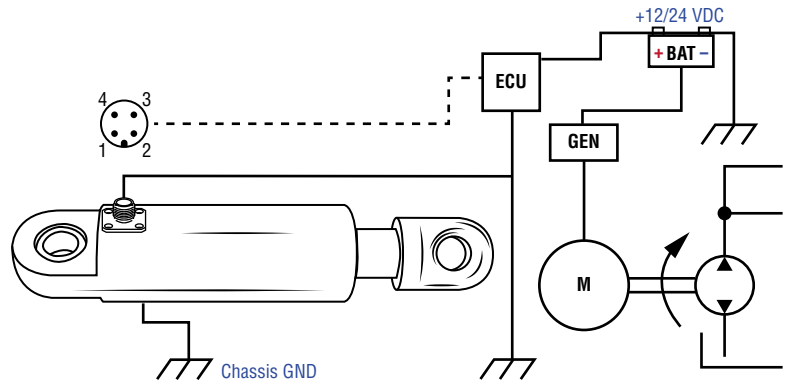


Fig. 9: Connection schematics

## MECHANICAL INSTALLATION

### Installation in a hydraulic cylinder

The robust Temposonics® MH sensor is designed for direct stroke measurement in hydraulic cylinders.

The Temposonics® MH sensor can be installed from the head side or the rod side of the cylinder depending on the cylinder design. In both installation methods, the sensor seals the cylinder by using an O-ring and backup ring which is installed on the sensor housing.

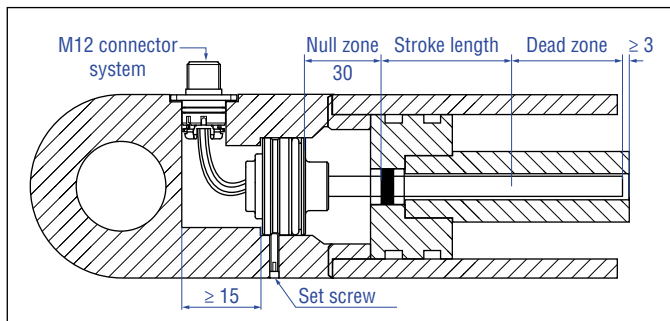


Fig. 10: Example of In-Cylinder assembly with M12 connector system

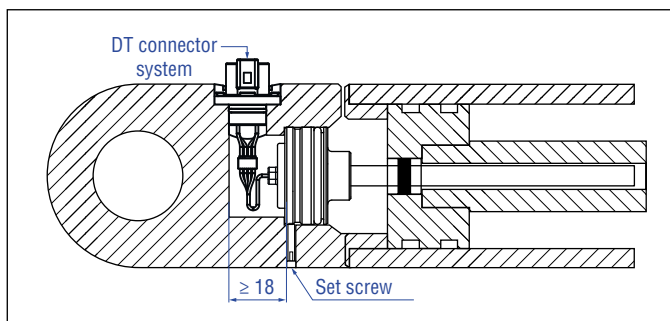


Fig. 11: Example of In-Cylinder assembly with DT connector system

### NOTICE

Installation Manual for MH sensors ([document part no. 551289](#))  
Installation Manual for DT connector system  
([document part no. 552093](#))

### NOTICE

#### Sealing:

- Take action against water ingress by sealing the cavity on the cover side.
- Cable glands should have IP69K rating.

#### Pressure:

- Do not exceed the operating pressure.

#### Avoid part collision:

- The bore depth in piston:  
Null zone + stroke length + dead zone + > 3 mm
- The position magnet shall not touch the pressure pipe.
- Note the piston rod drilling:  
- Ø 7 mm rod: ≥ Ø 10 mm  
- Ø 10 mm rod: ≥ Ø 13 mm

### Space requirements

#### M12 connector system / cable outlet

B	D	d	H	h
52 mm	48H8	> 32.5 mm < 40 mm	21.2 mm	> 15 mm

#### DT connector system

B	D	d	H	h
52 mm	48H8	> 32.5 mm < 40 mm	21.2 mm	> 18 mm

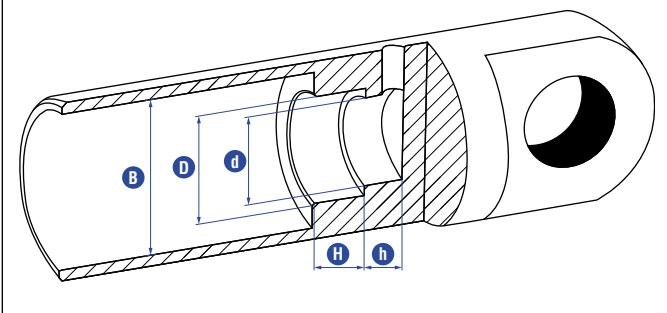


Fig. 12: Space requirements for cylinder

### Set screw

e.g. retaining with set screw (with flat point) ISO 4026 M5×10 (DIN 913).  
Fastening torque: ≤ 0.5 Nm

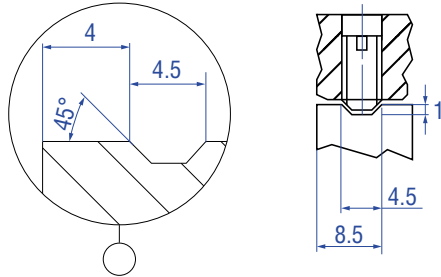


Fig. 13: Set screw

### NOTICE

#### Avoid sensor damage:

- The screw may touch the sensor housing.
- Tightening torque: ≤ 0.5 Nm.

#### Lock set screw:

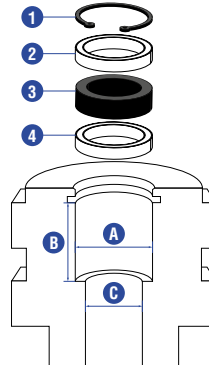
- Lock the set screw against falling out.
- Make sure that the threads are free of oil, grease and dirt.

#### Sealing:

- Consider a seal against water ingress (capillary effect).

## MECHANICAL INSTALLATION – POSITION MAGNET

### Magnet installation



- 1 Circlip
- 2 Non-magnetic spacer
- 3 Position magnet
- 4 Non-magnetic spacer (≥ 5 mm)

#### Position magnet (Part no.)

	401 032	400 533	201 542-2
<b>A</b>	17.4 mm	25.4 mm	32.8 mm
<b>B</b>	≥ 18 mm	≥ 18 mm	≥ 18 mm
<b>C</b>	Rod Ø 7 mm →	Piston rod drilling ≥ Ø 10 mm	
	Rod Ø 10 mm →	Piston rod drilling ≥ Ø 13 mm	

Fig. 14: Dimensions for magnet mounting

### NOTICE

Spacers, circlip, pretension parts etc. are not part of Temposonics shipment!

## ORDER CODE

1	2	3	4	5	6	7	8	9	10	11	12	13	14	15	16	17	18	19	20	21	22	
M	H						M					3										
a		b	c					d					e	f			g	h		i	j optional	

<b>a</b>	<b>Sensor model</b>
M H	Pressure fit flange

<b>b</b>	<b>Design</b>
Ø 10 mm rod	
C	Rod: Ø 10 mm + flat end plug / Dead zone: 63.5 mm / Stroke length: 50...2500 mm
E	Rod: Ø 10 mm + flat end plug / Dead zone: 36.5 mm / Stroke length: 50...1200 mm
L	Rod: Ø 10 mm + end plug with female M6 thread / Dead zone: 69.5 mm / Stroke length: 50...2500 mm
R	Rod: Ø 10 mm + end plug with female M4 thread / Dead zone: 69.5 mm / Stroke length: 50...2500 mm
Ø 7 mm rod	
D	Rod: Ø 7 mm + flat end plug / Dead zone: 63.5 mm / Stroke length: 50...2500 mm
F	Rod: Ø 7 mm + flat end plug / Dead zone: 36.5 mm / Stroke length: 50...1200 mm

<b>c</b>	<b>Stroke length</b>
X X X X M	0050...2500 mm

<b>d</b>	<b>Electrical wiring</b>
<b>M12 connector (VDC – GND – HI – LO) incl. flange</b>	
N	60...240 mm wire length (in 20 mm steps) Examples wire length N06F = 60 mm Connector wiring: F: 2-3-4-5
<b>M12 dual connector (VDC – GND – HI – LO) incl. flange</b>	
V	60...240 mm wire length (in 20 mm steps) Examples wire length N06F = 60 mm Connector wiring: F: 2-3-4-5
<b>Single wires</b>	
N	60...240 mm wire length (in 20 mm steps) Examples wire length N20A = 200 mm
<b>Cable outlet</b>	
T	300...9900 mm cable length (in 100 mm steps) Examples wire length T10A = 1000 mm
<b>DT connector system (VDC – GND – HI – LO)</b>	
A	60...240 mm wire length (in 20 mm steps) Connector wiring: 1-3-4-2

<b>e</b>	<b>Operating voltage</b>
3	+12/24 VDC (8...32 VDC)

<b>f</b>	<b>Output</b>
C 0 1	CANopen with cycle time 1 ms (default setting)
J 0 1	SAE J1939 with cycle time 20 ms (default setting)

<b>g</b>	<b>Baud rate</b>
<b>CANopen (C01)</b>	
0	1000 kbit/s
1	800 kbit/s
2	500 kbit/s
3	250 kbit/s (default)
4	125 kbit/s
6	50 kbit/s
7	20 kbit/s
8	10 kbit/s
<b>SAE J1939 (J01)</b>	
2	500 kbit/s
3	250 kbit/s (default)

<b>i</b>	<b>Node ID (CANopen) / Source address (SAE J1939)</b>
<b>CANopen (C01)</b>	
	Hex 01...7F (default: 7F)
<b>SAE J1939 (J01)</b>	
	Hex 01...FD (default: FD)

<b>j</b>	<b>Operating temperature</b>
L	-40...+85 °C (-40...+185 °F)

### optional

<b>k</b>	<b>Conical end plug</b>
K 1	Conical end plug for design C, D, E, F

**NOTICE**  
 The dead zone for designs with Ø 10 mm (C, E) will be extended by 2 mm!  
 The dead zone for designs with Ø 7 mm (D, F) will be extended by 2.5 mm!

## DELIVERY

---

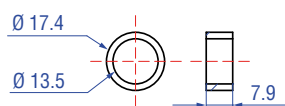


- Position sensor
  - O-ring
  - Backup-ring
  - M12 connector system incl. M12 flange (when option selected)
  - DT connector system incl. connector assembly and retainer (when option selected)
- Accessories (e.g. position magnets) have to be ordered separately

Manuals, Software & 3D models available at:  
[www.temposonics.com](http://www.temposonics.com)

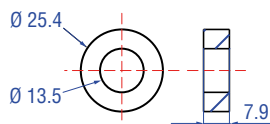
## FREQUENTLY ORDERED ACCESSORIES

### Position magnets



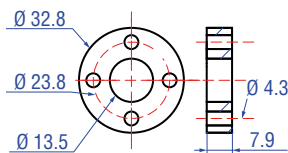
**Ring magnet OD17.4**  
Part no. 401 032

Material: PA neobond  
Weight: Approx. 5 g  
Surface pressure: Max. 20 N/mm<sup>2</sup>  
Operating temperature:  
-40...+105 °C (-40...+221 °F)



**Ring magnet OD25.4**  
Part no. 400 533

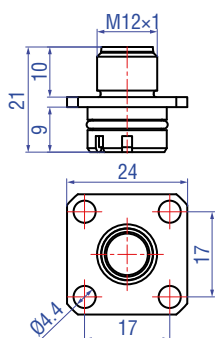
Material: PA ferrite  
Weight: Approx. 10 g  
Surface pressure: Max. 40 N/mm<sup>2</sup>  
Operating temperature:  
-40...+105 °C (-40...+221 °F)



**Ring magnet OD33**  
Part no. 201 542-2

Material: PA ferrite GF20  
Weight: Approx. 14 g  
Surface pressure: Max. 40 N/mm<sup>2</sup>  
Fastening torque for M4 screws: 1 Nm  
Operating temperature:  
-40...+105 °C (-40...+221 °F)

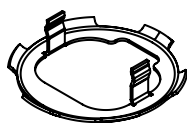
### M12 flange



**M12 Flange**  
Part no. 253 769

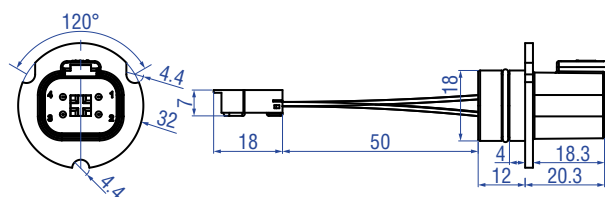
Material: Brass, nickel-plated  
Weight: Approx. 5 g  
Operating temperature:  
-40...+105 °C (-40...+221 °F)

### Connector accessories



**DT connector system retainer**  
Part no. 520 101




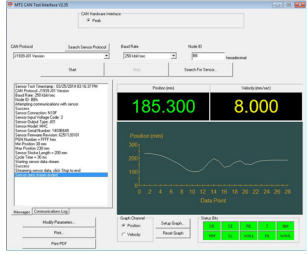
Material: 1.4310  
Weight: Ca. 1.7 g  
Operating temperature:  
-40...+105 °C (-40...+221 °F)




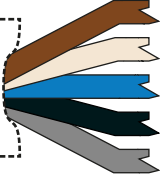


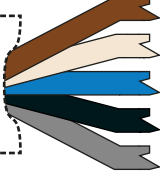

**DT connector assembly**  
Part no. 255 098

Material: PA66  
Weight: Approx. 6 g  
Operating temperature:  
-40...+105 °C (-40...+221 °F)

**Test kit**

	 	
<p><b>Testkit CANbus for EU</b> Part no. 254 267</p>	<p><b>Testkit CANbus for US</b> Part no. 253 879</p>	<p><b>Testsoftware CANbus</b> Part no. 625 129</p>
<p><b>Kit includes:</b> 1 × USB CAN-Modul 1 × Manual 1 × USB cable with M12 connector and D-SUB connector 1 × cable with D-SUB connector 1 × carrying case 1 × 12 VDC power supply</p>	<p><b>Kit includes:</b> 1 × Software 1 × USB CAN-Module 1 × Manual 1 × USB cable with M12 connector and D-SUB connector 1 × cable with D-SUB connector 1 × carrying case 1 × 12 VDC power supply</p>	<p>Software for MH CANbus</p>

**Cables**

	<p><b>Cable with M12 A-coded female connector (5 pin), straight – pigtail</b> Part no. 370 673</p> <p>Material: PUR jacket; black Features: Shielded Cable length: 5 m (16.4 ft) Ingress protection: IP67 (correctly fitted) Operating temperature: -25...+80 °C (-13...+176 °F)</p>	<p><b>Wiring</b></p>			
		<p><b>Wires</b></p> 	<p><b>Color</b></p> <p>BN ↔ 1</p> <p>WH ↔ 2</p> <p>BU ↔ 3</p> <p>BK ↔ 4</p> <p>GY ↔ 5</p>	<p><b>Pin</b></p>	<p><b>M12 A-coded female connector (5 pin)</b></p> 
	<p><b>Cable with M12 A-coded female connector (5 pin), angled – pigtail</b> Part no. 370 675</p> <p>Material: PUR jacket; black Features: Shielded Cable length: 5 m (16.4 ft) Ingress protection: IP67 (correctly fitted) Operating temperature: -25...+80 °C (-13...+176 °F)</p>	<p><b>Wiring</b></p>			
		<p><b>Wires</b></p> 	<p><b>Color</b></p> <p>BN ↔ 1</p> <p>WH ↔ 2</p> <p>BU ↔ 3</p> <p>BK ↔ 4</p> <p>GY ↔ 5</p>	<p><b>Pin</b></p>	<p><b>M12 A-coded female connector (5 pin)</b></p> 

**UNITED STATES**  
**Temposonics, LLC**  
Americas & APAC Region  
3001 Sheldon Drive  
Cary, N.C. 27513  
Phone: +1 919 677-0100  
E-mail: [info.us@temposonics.com](mailto:info.us@temposonics.com)

---

**GERMANY**  
**Temposonics**  
**GmbH & Co. KG**  
EMEA Region & India  
Auf dem Schüffel 9  
58513 Lüdenscheid  
Phone: +49 2351 9587-0  
E-mail: [info.de@temposonics.com](mailto:info.de@temposonics.com)

---

**ITALY**  
Branch Office  
Phone: +39 030 988 3819  
E-mail: [info.it@temposonics.com](mailto:info.it@temposonics.com)

---

**FRANCE**  
Branch Office  
Phone: +33 6 14 060 728  
E-mail: [info.fr@temposonics.com](mailto:info.fr@temposonics.com)

---

**UK**  
Branch Office  
Phone: +44 79 21 83 05 86  
E-mail: [info.uk@temposonics.com](mailto:info.uk@temposonics.com)

---

**SCANDINAVIA**  
Branch Office  
Phone: +46 70 29 91 281  
E-mail: [info.sca@temposonics.com](mailto:info.sca@temposonics.com)

---

**CHINA**  
Branch Office  
Phone: +86 21 3405 7850  
E-mail: [info.cn@temposonics.com](mailto:info.cn@temposonics.com)

---

**JAPAN**  
Branch Office  
Phone: +81 3 6416 1063  
E-mail: [info.jp@temposonics.com](mailto:info.jp@temposonics.com)

---

**Document Part Number:**  
551959 Revision D (EN) 03/2023



**temposonics.com**