

Operation Manual

GTE Analog

Magnetostrictive Linear Position Sensors



Table of contents

1. Introduction	3
1.1 Purpose and use of this manual	3
1.2 Used symbols and warnings	3
2. Safety instructions	3
2.1 Intended use	3
2.2 Foreseeable misuse	3
2.3 Installation, commissioning and operation	4
2.4 Safety instructions for use in explosion-hazardous areas	5
2.5 Warranty	5
2.6 Return	5
3. Identification	6
3.1 Order code of Temposonics® GTE	6
3.2 Nameplate	7
3.3 Approvals	7
3.4 Scope of delivery	7
4. Product description and commissioning	8
4.1 Functionality and system design	8
4.2 Styles of Temposonics® GTE	9
4.3 Electrical connection	9
4.4 Frequently ordered accessories	10
5. Installation	10
5.1 Measuring range	10
5.2 Mounting instructions	10
5.3 Safety screw	11
6. Inspection, maintenance, others	11
6.1 Assembly, disassembly	11
6.2 Inspection and maintenance	11
6.3 Fault clearance	11
6.4 Disposal	11
7. Technical data Temposonics® GTE Analog ATEX / UKCA / IECEx / NEC / CEC / CCC	12
8. Certifications	13
9. Declaration of conformity of GTE Analog	13
10. Appendix	14

1. Introduction





1.1 Purpose and use of this manual

Before starting the operation of Temposonics® position sensors, read this documentation thoroughly and follow the safety information. Keep this manual for future reference!

The content of this technical documentation and of its appendix is intended to provide information on mounting, installation and commissioning by qualified automation personnel ¹ or instructed service technicians who are familiar with the project planning and dealing with Temposonics® sensors.

1.2 Used symbols and warnings

Warnings are intended for your personal safety and for avoidance of damage to the described product or connected devices. In this documentation, safety information and warnings to avoid dangers that might affect the life and health of operating or service personnel or cause material damage are highlighted by the preceding pictograms, which are defined below.

Symbol	Meaning
	This symbol is used to point to situations that may lead to material damage, but not to personal injury.
	This sign identifies an important information
	This sign indicates that, personnel damage such as death or bodily injury, or considerable damage to property are susceptible to occur, unless appropriate precautions are taken.
	Information related to potential explosion hazards and its protective measures.

2. Safety instructions

2.1 Intended use

This product may be used only for the applications defined under item 1 and only in conjunction with the third-party devices and components recommended or approved by Temposonics. As a prerequisite of proper and safe operation the product requires correct transport, storage, mounting and commissioning and must be operated with utmost care.

^{1/} The term "qualified technical personnel" characterizes persons who:

- are familiar with the safety concepts of automation technology applicable to the particular project
- are competent in the field of electromagnetic compatibility (EMC)

1. The position measurement systems of all Temposonics® series are intended exclusively for measurement in industrial, trade and laboratory applications. The position sensors are considered as system accessories and must be connected to a suitable unit for electronic evaluation as e.g. included in a PLC, IPC, indicator or other electronic control facility.
2. The position sensors must be used only in safe condition. In order to maintain this condition and to ensure safe operation, installation, connection and service may be done only by specialized and qualified personnel.
3. The position sensor is intended to be embedded into a metallic hydraulic cylinder which protects it from external mechanical impacts.
4. The sensor's surface temperature class is T4.
5. The position sensor may be used in the Zones (ATEX, IECEx, UKCA, CCC) and Classes, Zones and Divisions (CEC, NEC) according to chapter 8.

2.2 Forseeable misuse

Forseeable misuse	Consequence
Lead compensating currents through the enclosure	The sensor will be damaged
Wrong sensor connection	The sensor will not work properly or will be destroyed
Operate the sensor out of the operating temperature range	No signal output The sensor can be damaged
Power supply is out of the defined range	Signal output is wrong / no signal output / the sensor will be damaged
Position measurement is influenced by an external magnetic field	Signal output is wrong
Cables are damaged	Short circuit – the sensor can be destroyed / sensor does not respond
Spacers are missing / are installed in a wrong order	Error in position measurement
Wrong connection of ground / shield	Signal output is disturbed The electronics can be damaged
Use of a magnet that is not certified by Temposonics	Error in position measurement

- have received adequate training for commissioning and service operations
- are familiar with the operation of the device and know the information required for correct operation provided in the product documentation
- have a qualification similar to "authorized person" according to TRBS 1203

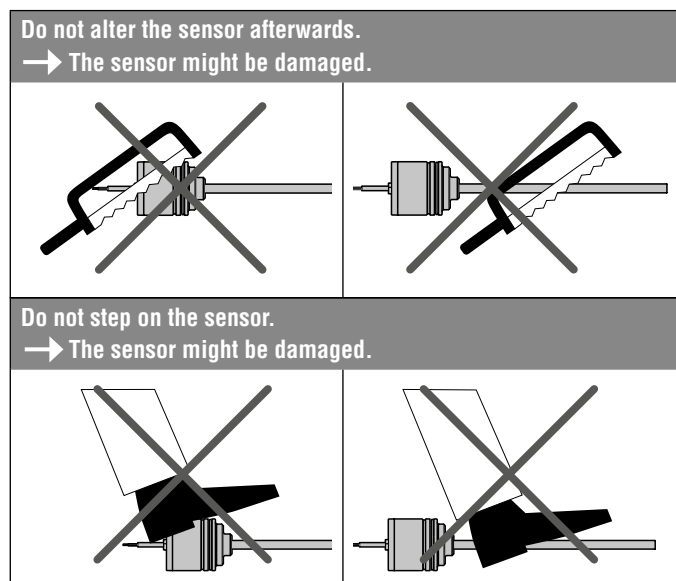

2.3 Installation, commissioning and operation

The position sensor is an electrical apparatus for use in Zone 2 (ATEX/IECEX/UKCA/CCC), Class I/II/III Div. 2 and Zone 2 and Zone 22 (NEC/CEC) and must be used only in technically safe condition. To maintain this condition and to ensure safe operation, installation, connection and service, work may be performed only by qualified technical personnel, according to IEC 60079-14 and local regulations. If danger of injury to persons or of damage to operating equipment is caused by sensor failure or malfunction, additional safety measures such as plausibility checks, limit switches, EMERGENCY STOP systems, protective devices etc. are required. In the event of trouble, shut down the sensor and protect it against accidental operation.

2.3.1 Safety instructions for commissioning

To maintain the sensor's operability, it is mandatory to follow the instructions given below.

1. Follow the specifications given in the technical data.
2. Ensure that equipment and associated components used in a hazardous environment are selected and installed in compliance with regulations governing the geographical location and facility. Only install equipment that complies with the types of protection relevant to the applicable Classes, Zones, Divisions and Groups.
3. In explosive atmospheres use only such auxiliary components that meet all requirements of the local and national standards.
4. The potential equalisation of the system has to be established according to the regulations of erection applicable in the respective country of use (VDE 0100 part 540; IEC 364-5-54).
5. Sensors from Temposonics are approved only for the intended use in industrial environments (see chapter "2.1 Intended use" on page 3). Contact the manufacturer for advice if aggressive substances are present in the sensor environment.
6. Measures for lightning protection have to be taken by the user.
7. The user is responsible for the mechanical protection of the sensor.

8. The sensor may be used only for fixed installations with permanently wired cables. The user shall ensure that cables and cable glands correspond to the risk assessment of the hazardous application as well as to thermic, chemical and mechanical environmental conditions. The user is also responsible for the required strain relief. When selecting the sealing, the maximum thermal load of the cables must be taken into account.
9. The user is responsible for meeting all safety conditions as outlined by:
 - Installation instructions
 - Local prevailing standards and regulations
10. Any parts of the equipment which got stuck (e.g. by frost or corrosion) may not be removed by force if potentially explosive atmosphere is present.
11. The surface temperatures of equipment parts must be kept clearly below the ignition temperature of the foreseeable air/dust mixtures in order to prevent the ignition of suspended dust.

2.3.2 How to ensure safe commissioning

1. Protect the sensor against mechanical damage during installation and operation.
2. Do not use damaged products and secure them against unintentional commissioning. Mark damaged products as being defective.
3. Do not open or disassemble the sensor.
4. Do not open whilst energised.
5. Do not open when an explosive atmosphere is present.
6. The clamping test of the cable entry was carried out with a reduced value, so it has to be ensured that pulling and twisting of the cable is not transmitted to the terminations.
7. The mechanical protection of the sensor has to be provided by the cylinder in which the sensor is embedded.
8. Prevent electrostatic charges.
9. Do not use the sensor in cathodic systems for corrosion protection. Do not allow parasitic currents on the sensor housing.
10. Switch off the supply voltage prior to disconnecting or connecting the connectors.
11. Connect the sensor very carefully and pay attention to the polarity of connections, power supply as well as to the shape and duration of control pulses.
12. Cable entry temperature and branching point temperature may reach +75 °C (+167 °F) for power option 1. Select suitable cable and entry device.
13. For field wiring, use cables suitable for the service temperature range of -20 °C (-4 °F) to +75 °C (+167 °F).
14. Use only approved power supplies of Category II according to IEC 61010-1.

15. Ensure that the specified permissible limit values of the sensor for operating voltage, environmental conditions, etc. are met.
16. Make sure that:
 - the sensor and associated components were installed according to the instructions
 - the sensor enclosure is clean
 - the magnet does not grind on the rod. This could cause damage to the magnet and the sensor rod. If there is contact between the moving magnet (including the magnet holder) and the sensor rod, make sure that the maximum speed of the moving magnet is less or equal 1 m/s.
17. Grounding of the system (sensor + cylinder) to the local earth has to be done at the metallic cylinder. To ensure proper electrical grounding, the connection between the sensor housing and the metallic cylinder (or housing) must be ensured by fasteners (e.g., screws).
18. Before applying power, ensure that nobody's safety is jeopardized by starting machines.
19. Check the function of the sensor regularly and provide documentation of the checks (see chapter "5.2 Mounting instructions" on page 10).

2.4 Safety instructions for use in explosion-hazardous areas

The sensor has been designed for operation inside explosion-hazardous areas. It has been tested and left the factory in a condition in which it is safe to operate. Relevant regulations and standards have been observed. According to the marking (ATEX, IECEx, UKCA and NEC/CEC) the sensor is approved only for operation in defined hazardous areas (see chapter "2.1 Intended use" on page 3 and table in chapter 8).

Special condition of use:

- The position sensor shall only be used in an area of at least pollution degree 2, as defined in IEC 60664-1
- The position sensor shall be installed in an enclosure provided a minimum ingress protection of IP54.
- Transient protection shall be provided that is set at a level not exceeding 140% of the peak rated voltage value at the supply terminals of the sensor.

2.5 Warranty

Temposonics grants a warranty period for the Temposonics® position sensors and supplied accessories relating to material defects and faults that occur despite correct use in accordance with the intended application ². The Temposonics obligation is limited to repair or replacement of any defective part of the unit. No warranty can be provided for defects that are due to improper use or above average stress of the product, as well as for wear parts. Under no circumstances will Temposonics accept liability in the event of offense against the warranty rules, no matter if these have been assured or expected, even in case of fault or negligence of the company. Temposonics explicitly excludes any further warranties. Neither the company's representatives, agents, dealers nor employees are authorized to increase or change the scope of warranty.

2.6 Return

For diagnostic purposes, the sensor can be returned to Temposonics or a repair facility explicitly authorized by Temposonics. Any shipment cost is the responsibility of the sender ². For a corresponding form, see chapter "10. Appendix" on page 14.

NOTICE

When returning sensors, place protective caps on male and female connectors of the sensor. For pigtail cables, place the cable ends in a static shielding bag for electrostatic discharge (ESD) protection. Fill the outer packaging around the sensor completely to prevent damage during transport.

^{2/} See also applicable Temposonics terms of sales and delivery on: www.temposonics.com

3. Identification

3.1 Order code of Temposonics® GTE

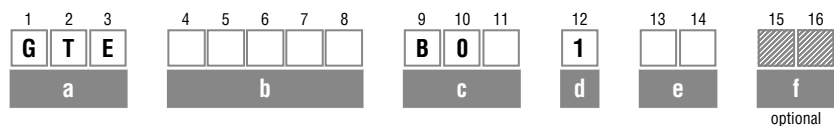

a	Sensor model
G T E	Embedded pressure-fit flange Ø 60 mm (2.36 in.)

b	Stroke length
X X X X M	0050...2540 mm

Standard stroke length (mm)	Ordering steps
50... 500 mm	5 mm
500... 750 mm	10 mm
750... 1000 mm	25 mm
1000... 2540 mm	50 mm

Standard stroke length (in.)	Ordering steps
2... 20 in.	0.2 in.
20... 30 in.	0.4 in.
30... 40 in.	1.0 in.
40... 100 in.	2.0 in.

Non-standard stroke lengths are available; must be encoded in 5 mm/0.1 in. increments.

c	Connection type
B 0 1	1 m/3 ft. TPV cable (part no. 530 162)
B 0 3	3 m/10 ft. TPV cable (part no. 530 162)
B 0 5	5 m/16 ft. TPV cable (part no. 530 162)

d	Operating voltage
1	+24 VDC (-15/+20 %) (T _{amb} max. +75 °C (+167 °F))

e	Output
A 0	4...20 mA
A 1	20...4 mA
A 2	0...20 mA
A 3	20...0 mA
V 0	0...+10 VDC
V 1	+10...0 VDC
V 2	-10...+10 VDC
V 3	+10...-10 VDC

Optional:

f	Agency approval
E X	Approved version

3.2 Nameplate

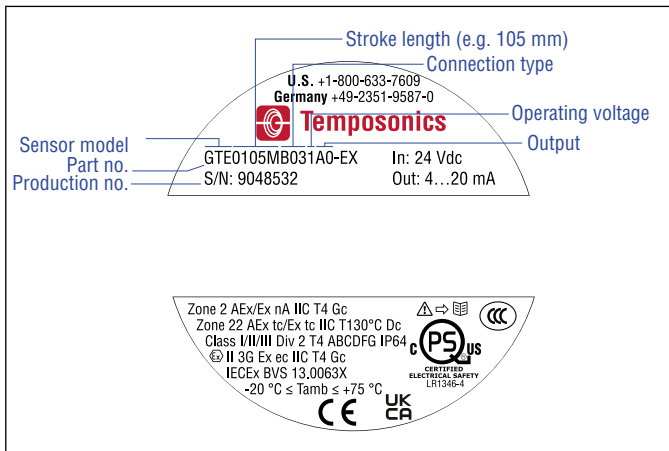

Fig. 1: Example of a nameplate of a GTE sensor

3.3 Approvals

See chapter “7. Technical data Temposonics® GTE Analog ATEX / UKCA / IECEx / NEC / CEC / CCC” on page 12 – 13.

NOTICE

For detailed overview of the certifications, see www.temposonics.com

3.4 Scope of delivery

GTE (rod sensor):

- Sensor
- O-ring
- Back-up ring

4. Product description and commissioning

4.1 Functionality and system design

Product designation

- Position sensor Temposonics® G-Series

Sensor model

- Temposonics® GTE (rod sensor)

Stroke length

- Stroke length: 50...2540 mm (2...100 in.)

Output signal

- Analog

Application

Temposonics® position sensors are used for measurement and conversion of the length (position) variable in the fields of automated systems and mechanical engineering.

The GTE type sensors consist of several (in this case two) independent sensor channels in one housing for redundancy. That means, they contain two waveguides, two independent electronics and two output cables.

The adjustment of the setpoints (null/span) is possible in 100 % of the electrical stroke length with 50 mm (2 in.) minimum distance between each setpoint.

The GTE sensors are designed as sensors to be embedded into hydraulic cylinders. This means that part of the mechanical protection is done by the hydraulic cylinder rather than by the sensor itself.

Principle of operation and system construction

The absolute, linear position sensors provided by Temposonics rely on the company's proprietary Temposonics® magnetostrictive technology, which can determine position with a high level of precision and robustness.

Each Temposonics® position sensor consists of a ferromagnetic waveguide, a position magnet, a strain pulse converter and supporting electronics. The magnet, connected to the object in motion in the application, generates a magnetic field at its location on the waveguide. A short current pulse is applied to the waveguide. This creates a momentary radial magnetic field and torsional strain on the waveguide. The momentary interaction of the magnetic fields releases a torsional strain pulse that propagates the length of the waveguide. When the ultrasonic wave reaches the end of the waveguide it is converted into an electrical signal. Since the speed of the ultrasonic wave in the waveguide is precisely known, the time required to receive the return signal can be converted into a linear position measurement with both high accuracy and repeatability.

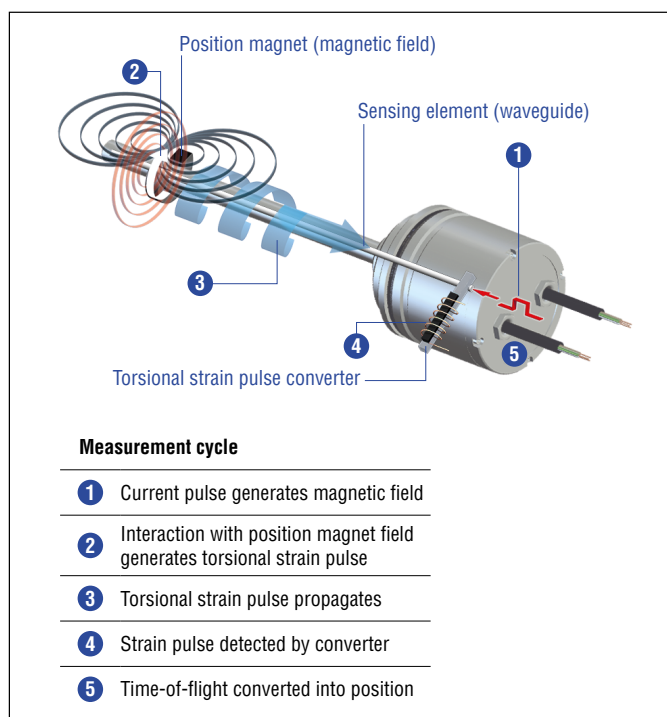

Fig. 2: Time-of-flight based magnetostrictive position sensing principle

4.2 Styles of Temposonics® GTE

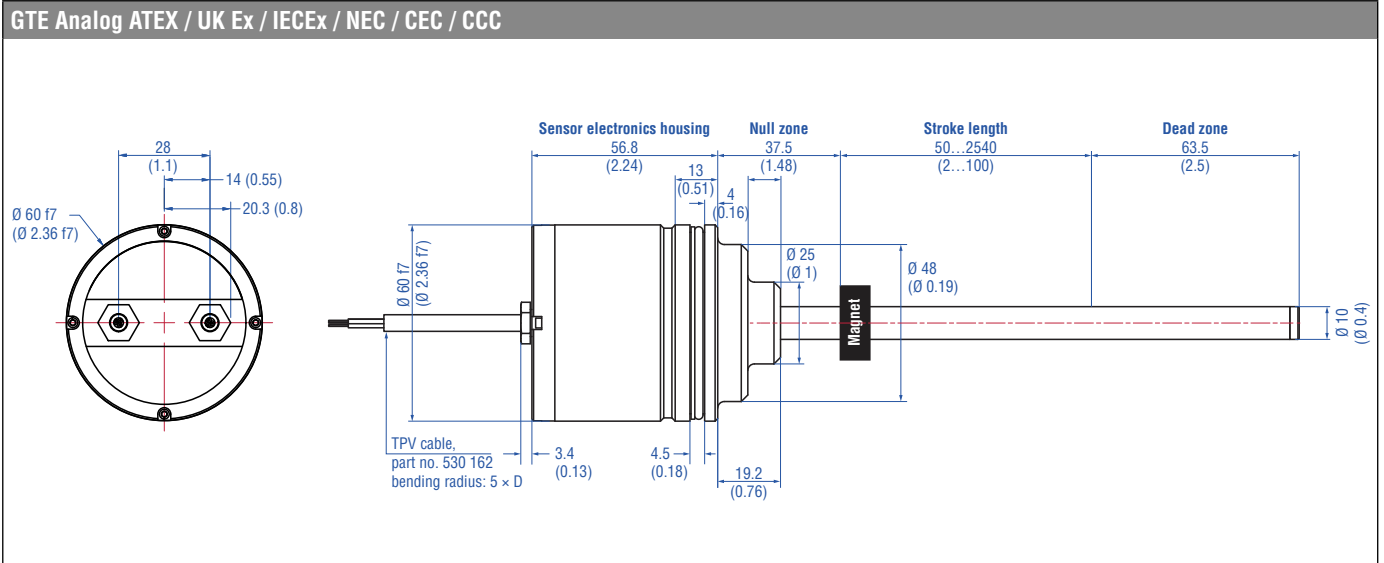

Fig. 3: Temposonics® GTE with ring magnet

4.3 Electrical connection

Connector wiring

Connect the sensor directly to the control system, indicator or other evaluating systems as follows:

B.XX		
Signal + power supply		
Cable	Color	Function
	GY	Position
	PK	Return for output
	YE	Programming (RS-485 +)
	GN	Programming (RS-485 -)
	BN	Supply voltage
	WH	DC Ground (0 V)
	Shield	Only connected on controller side

Fig. 4: Connector wiring: 6-wire shielded cable

4.4 Frequently ordered accessories – Additional options available in our [Accessories Guide](#) 551444

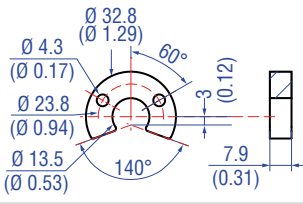
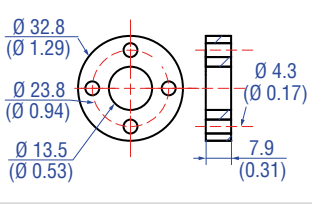
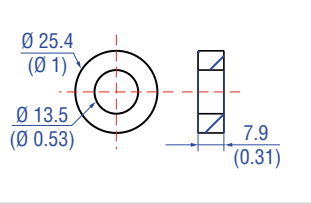
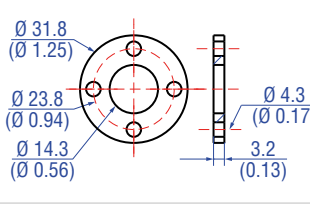
Position magnets		Magnet spacer	
			
U-magnet OD33 Part no. 251 416-2	Ring magnet OD33 Part no. 201 542-2	Ring magnet OD25.4 Part no. 400 533	Magnet spacer Part no. 400 633
Material: PA ferrite GF20 Weight: Approx. 11 g Surface pressure: Max. 40 N/mm ² Fastening torque for M4 screws: 1 Nm Operating temperature: -40...+105 °C (-40...+221 °F)	Material: PA ferrite GF20 Weight: Approx. 14 g Surface pressure: Max. 40 N/mm ² Fastening torque for M4 screws: 1 Nm Operating temperature: -40...+105 °C (-40...+221 °F)	Material: PA ferrite Weight: Approx. 10 g Surface pressure: Max. 40 N/mm ² Operating temperature: -40...+105 °C (-40...+221 °F)	Material: Aluminum Weight: Approx. 5 g Surface pressure: Max. 20 N/mm ² Fastening torque for M4 screws: 1 Nm

Programming tool



Hand programmer for analog output
Part no. 253 853

Easy teach-in-setups of stroke length and direction on desired zero / span positions. For sensors with 1 magnet.

5. Installation

5.1 Measuring range

All the technical data of each Temposonics® sensor are checked and recorded at the final quality inspection. At the same time the active electrical stroke is programmed.

NOTICE
On all sensors, the areas left and right of the active stroke length are provided for null and dead zone. These zones should not be used for measurement, however the active stroke length can be exceeded.

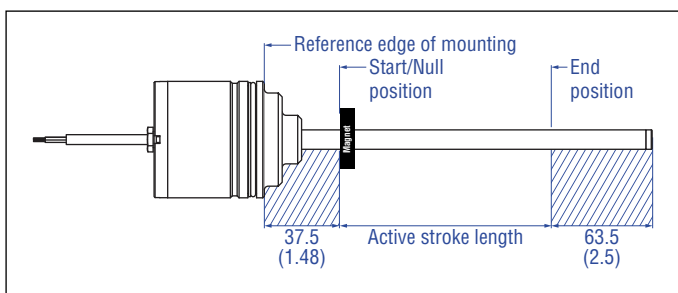

Fig. 5: Null zone, active stroke length, dead zone

5.2 Mounting instructions

1. O-ring and back-up ring have been fitted at the factory.
2. Lubricate O-ring and back-up ring before mounting into the cylinder.
3. Push the sensor into the seat carefully. Make sure that the cables and conductors are not under strain.
4. Carefully route the cables through the cylinder wall. Avoid tensile stress acting on the connecting cable.
5. Never expose the connecting cable to tensile stress and protect it against sharp edges. Sharp edges could damage the insulation of the connecting cables.
6. The bending radius of the cable must not be less than 25 mm (0.98 in.)
7. Terminate the wires on the controller side per the electrical connection table (refer to chapter 4.3, Fig. 4) regularly.

Controlling design dimensions are in millimeters and measurements in () are in inches

5.3 Safety screw

A M5×10 set screw to ISO 4026 with flat point should be used. This safety screw is only required for blocking the sensor housing in axial direction and needs to butt only against the groove, i.e. the screw may be tightened only with a torque of 0.5 Nm to prevent damaging the sensor. The set screw should be inserted with a resolvable safety adhesive, e.g. Loctite blue.

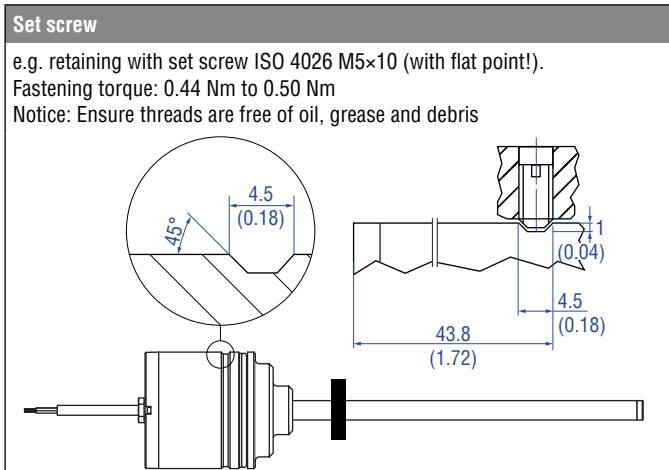

Fig. 6: Set screw for GTE sensor

NOTICE

The safety screw must be sealed to prevent moisture or liquid from passing through during the cylinder production or later when the machine is operating!

6. Inspection, maintenance, others

6.1 Assembly, disassembly

During assembly and disassembly, it is important to follow best practices for working with electronic components.

Before using the device, please ensure the following:

- The device is installed according to the local and national regulations.
- The requirements for the applicable explosion category were taken into account.
- The device is not damaged.
- The installation location is clean.

6.2 Inspection and maintenance

Follow the definitions and regulations according to IEC 60079-17. Annual inspection should be conducted for the housing that contains the embedded sensor to ensure proper grounding.





6.3 Fault clearance

No modifications of the sensors are allowed.

6.4 Disposal

The disposal of the packaging materials and used parts has to take place according to the regulations of the country in which the device is installed.

7. Technical data Temposonics® GTE Analog ATEX / UKCA / IECEx / NEC / CEC / CCC

Output	
Voltage	0...10 VDC, 10...0 VDC, -10...+10 VDC, +10...-10 VDC (minimum controller load: > 5k Ω)
Current	4...20 mA, 20...4 mA, 0...20 mA, 20...0 mA (minimum/maximum load: 0/500 Ω)
Measured value	Position
Measurement parameters	
Resolution: Position	Infinite (restricted by output ripple)
Cycle time	< 1 ms (typical)
Linearity deviation	< ±0.02 % F.S. (minimum ±50 μm)
Repeatability	< ±0.001 % F.S. (minimum ±2.5 μm)
Hysteresis	< 4 μm
Operating conditions	
Operating temperature	-40...+75 °C (-40...+167 °F) 
Humidity	90 % relative humidity, no condensation
Ingress protection	IP64
Shock test	100 g (single shock) according to IEC 60068-2-27 (survivability)
Vibration test	10 g/10...2000 Hz according to IEC 60068-2-6 (resonance frequencies excluded)
EMC test	Electromagnetic emission according to EN 61326-1 and EN 55011 Electromagnetic immunity according to EN 61326-1 The GTE sensors fulfill the requirements of the EMC directives 2014/30/EU and, UKSI 2016 No. 1091
Operating pressure	350 bar static (5076 psi static), 690 bar peak (10,000 psi peak)
Agency approvals (optional)	
Non-sparking / Increased safety	 Class I Zone 2 AEx/Ex nA IIC T4 Gc Class II/III Zone 22 AEx tc/Ex tc IIC T130 °C Dc Class I/II/III Div 2 T4 ABCDFG  ATEX/IECEx/UKCA  II 3G Ex ec IIC T4 Gc  IECEx BVS 13.0063X Ex nA IIC T4 Gc -20 °C ≤ +75 °C (-4 °F ≤ +167 °F)
Design / Material	
Sensor electronics housing	Stainless steel 1.4305 (AISI 303)
Sensor rod	Stainless steel 1.4306 (AISI 304L)
RoHS compliance	The used materials are compliant with the requirements of EU Directive 2011/65/EU and EU Regulation 2015/863 as well as UKSI 2022 No. 622
Stroke length	50...2540 mm (2...100 in.)
Mechanical mounting	
Mounting position	Any
Mounting instruction	Please consult the technical drawing on page 9
Electrical connection	
Connection type	Cable output
Operating voltage	+24 VDC (-15/+20 %)
Current consumption	100 mA typical per channel
Dielectric strength	700 VDC (DC ground to machine ground)
Polarity protection	Up to -30 VDC
Overvoltage protection	Up to 36 VDC

8. Certifications

Certification required	GTE-xxxx-Bxx-1-xx-EX (+24 VDC (-15/+20 %))
IECEx / ATEX (IECEx: Global market; ATEX: Europe)	Ex ec IIC T4 Gc Zone 2 -40 °C ≤ Ta ≤ +75 °C (-40 °F ≤ Ta ≤ +167 °F)
UKCA (England, Wales and Scotland)	Ex ec IIC T4 Gc Zone 2 -40 °C ≤ Ta ≤ +75 °C (-40 °F ≤ Ta ≤ +167 °F)
NEC (USA)	Class I/II/III Div 2 T4 Groups ABCDFG Class I, Zone 2, AEx nA IIC T4 Class II/III, Zone 22, AEx tc IIC T130 °C -20 °C ≤ Ta ≤ +75 °C (-4 °F ≤ Ta ≤ +167 °F)
CEC (Canada)	Class I/II/III Div 2 T4 Groups ABCDFG Ex nA IIC T4 Gc Ex tc IIC T130 °C Dc -20 °C ≤ Ta ≤ +75 °C (-4 °F ≤ Ta ≤ +167 °F)
CCC (China)	Ex nA IIC T4 Gc -40 °C ≤ Ta ≤ +75 °C (-40 °F ≤ Ta ≤ +167 °F)

Fig. 7: Certifications GTE Analog

9. Declaration of conformity of GTE Analog

Latest certificates and approvals available at:
www.temposonics.com

10. Appendix

Safety declaration

Dear Customer,

If you return one or several sensors for checking or repair, we need you to sign a safety declaration. The purpose of this declaration is to ensure that the returned items do not contain residues of harmful substances and/or that people handling these items will not be in danger.

Temposonics order number: _____

Sensor type(s): _____

Serial number(s): _____

Sensor length(s): _____

The sensor has been in contact with the following materials:

Do not specify chemical formulas.
 Please include safety data sheets of the substances, if applicable.

In the event of suspected penetration of substances into the sensor, consult Temposonics to determine measures to be taken before shipment.

Short description of malfunction:

Corporate information

Company: _____

Address: _____

Contact partner

Phone: _____

Fax: _____

Email: _____

We hereby certify that the measuring equipment has been cleaned and neutralized.
 Equipment handling is safe. Personnel exposure to health risks during transport and repair is excluded.

Stamp

Signature

Date

UNITED STATES
Temposonics, LLC
Americas & APAC Region
3001 Sheldon Drive
Cary, N.C. 27513
Phone: +1 919 677-0100
E-mail: info.us@temposonics.com

GERMANY
Temposonics
GmbH & Co. KG
EMEA Region & India
Auf dem Schüffel 9
58513 Lüdenscheid
Phone: +49 2351 9587-0
E-mail: info.de@temposonics.com

ITALY
Branch Office
Phone: +39 030 988 3819
E-mail: info.it@temposonics.com

FRANCE
Branch Office
Phone: +33 6 14 060 728
E-mail: info.fr@temposonics.com

UK
Branch Office
Phone: +44 79 21 83 05 86
E-mail: info.uk@temposonics.com

SCANDINAVIA
Branch Office
Phone: +46 70 29 91 281
E-mail: info.sca@temposonics.com

CHINA
Branch Office
Phone: +86 21 3405 7850
E-mail: info.cn@temposonics.com

JAPAN
Branch Office
Phone: +81 3 6416 1063
E-mail: info.jp@temposonics.com

Document Part Number
551482 Revision D (EN) 02/2023



temposonics.com